

The 100 Most Frequently Cited OSHA Construction Standards in 1991: A Guide for the Abatement of the Top 25 Associated Physical Hazards

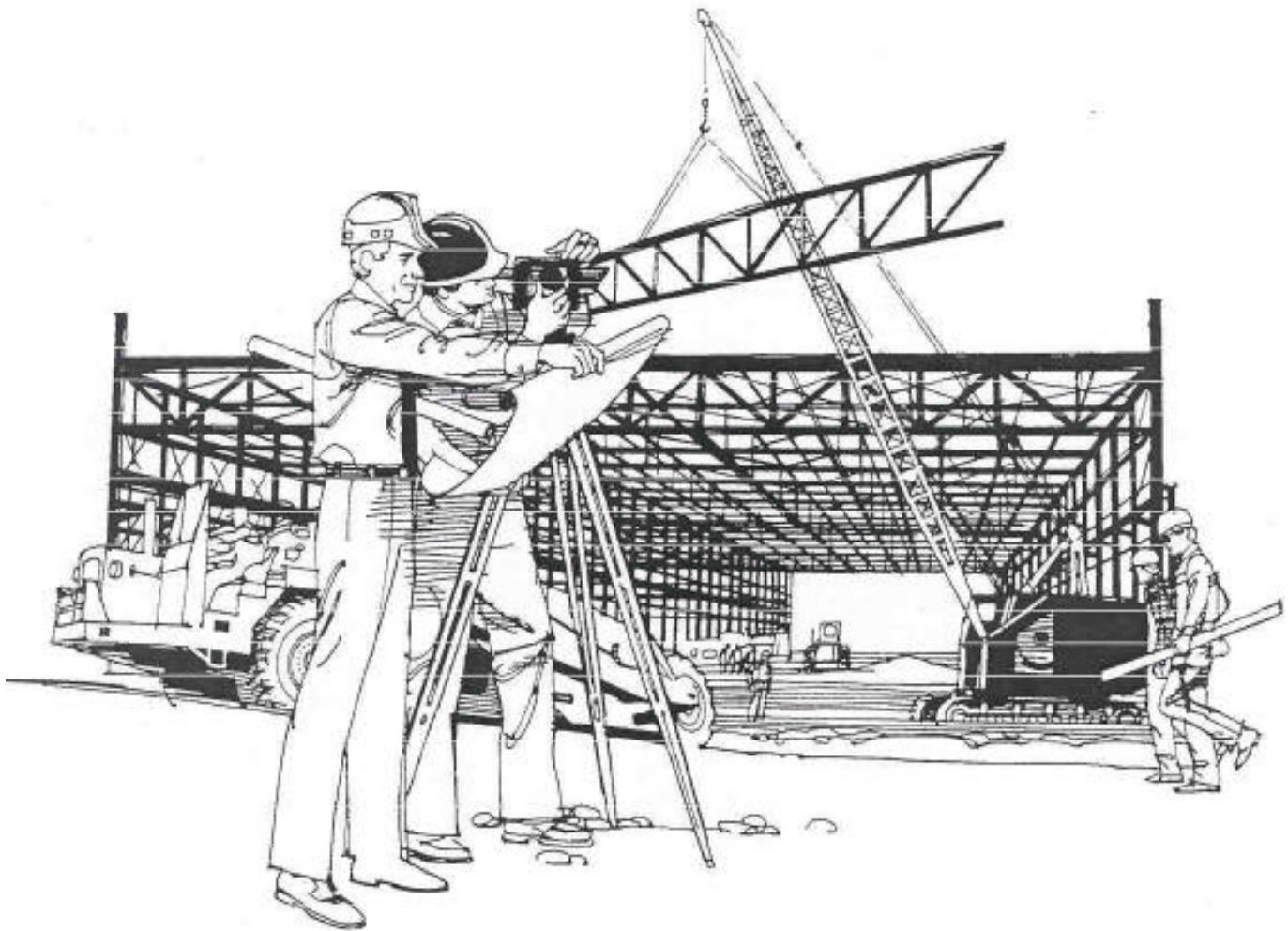

U.S. Department of Labor
Occupational Safety and Health Administration

March 1995 (Reprinted)



PUBLICATION DISCLAIMER

– OSHA's 100 Most Frequently Cited Standards:

The information contained in this document was correct at the time of publication in 1991. Several standards have changed since that time. The current standards may be viewed by selecting this hyperlink:

http://www.osha-slc.gov/OshStd_toc/OSHA_Std_toc_1926.html

There have been technological advances in safety equipment, and some of the acceptable abatement methods indicated are no longer the safest means to protect the worker. The current standards (link to standards) and Interpretations (http://www.osha-slc.gov/OshDoc/toc_interps.html) will assist you in determining the best examples to use for your training.

Material contained in this publication is in the public domain and may be reproduced, fully or partially, without permission of the Federal Government. Source credit is requested but not required.

The information contained in this publication is not considered a substitute for any provisions of the Occupational Safety and Health Act of 1970 or for any standards issued by OSHA.

This report was written by
Michael L. Marshall,
Civil Engineer
Charles Handesty,
Construction Safety Specialist

This information will be made available to sensory impaired individuals upon request.
Voice phone: (202)219-8644;
TDD message referral phone:
1-800-326-2577

The 100 Most Frequently Cited OSHA Construction Standards in 1991: A Guide for the Abatement of the Top 25 Associated Physical Hazards



U.S. Department of Labor
Robert B. Reich, Secretary

Occupational Safety and Health Administration
Joseph A. Dear, Assistant Secretary

Office of Construction and Engineering
Bruce Swanson, Director

March 1995 (Reprinted)

TABLE OF CONTENTS

	<u>Page</u>
ACKNOWLEDGEMENT.....	v
ABSTRACT.....	vii
SIMPLIFIED FLOW CHARTS OF CONTENTS OF REPORT.....	ix
1.0 INTRODUCTION.....	1
2.0 THE 100 MOST FREQUENTLY CITED OSHA CONSTRUCTION STANDARDS	5
3.0 100 MOST CITED PHYSICAL LIST	17
4.0 FORMAT AND USE OF GUIDE	27
4.1 USE OF GUIDE	27
4.2 FORMAT	28
5.0 GUIDE FOR THE ABATEMENT OF THE TOP 25 MOST CITED PHYSICAL HAZARDS.....	31
5.1 THE TOP 25 GUIDE SHEETS	31
5.2 CONSTRUCTION SPECIFICATIONS FOR GUARDRAILS AND TOEBOARDS.....	82
5.3 REFERENCES.....	84
INDEX.....	87

CONTENTS (CONTINUED)
LIST OF FIGURES AND TABLES

		<u>Page</u>
FIGURE 1-1	EMPLOYER'S SAFETY AND HEALTH PROGRAM	4
TABLE 2-1	100 MOST CITED CONSTRUCTION STANDARDS IN AND THEIR RELATIVE RANKING TO 1991	7
TABLE 2-2	THE MOST CITED CONSTRUCTION STANDARDS IN 1991 BY PERCENTAGE OF TOTAL VIOLATIONS	12
FIGURE 2-1	FREQUENCY OF PROGRAMMATIC VS. PHYSICAL VIOLATIONS: 100 MOST CITED VIOLATIONS IN 1991	14
FIGURE 2-2	DISTRIBUTION OF THE 100 MOST FREQUENTLY CITED STANDARDS BY SUBPART	15
TABLE 3-1	LIST OF THE 100 MOST FREQUENTLY CITED OSHA CONSTRUCTION STANDARDS RELATED TO PHYSICAL HAZARDS IN 1991	18
TABLE 3-2	GROUPING BY SUBJECT OF 100 MOST CITED PHYSICAL STANDARDS	22
TABLE 3-3	COMBINED STANDARDS BY SUBJECT MATTER FROM THE LIST OF 100 PHYSICAL STANDARDS IN 1991	23
TABLE 5.2-1	MINIMUM SPECIFICATIONS FOR GUARDRAIL SYSTEMS	82
TABLE 5.2-2	MINIMUM SPECIFICATIONS FOR TOEBOARDS	83

ACKNOWLEDGEMENTS

Staff from the OSHA National Office provided assistance in preparing this report. The following directors and their staffs provided information, review and comments for the report: Roy Gurnham from the Office of Construction and Maritime Compliance Assistance; Gerald Reidy from the Office of Construction and Civil Engineering Safety Standards; and Joseph Pipkin from the Office of Electrical and Electronic Engineering Safety Standards. The Office of Information and Consumer Affairs, Jim Foster, Director, Jim Blackmon and Sue Fleming provided editorial review and production assistance. Charles Culver, Director and Fred Anderson, Deputy Director from the Office of Construction and Engineering (OCE) provided direction and input for the report. Eugene Simms, Cooperative Education Student (OCE) spent considerable amount of time and effort tabulating data and developing computer graphic charts and tables.

Cathleen Cronin of the OSHA Training Institute provided direction and access to photographs, slides and documents which were used in this report. Manny Ypsilantes and Donovan Grentz provided information, photographs, review and comments for the report.

The following OSHA field personnel provided information, review and comments for the report: William Burke, Assistant Area Director, Region VI - Dallas, TX Area Office; Robert Holmes, Area Director and Mike Partin, Assistant Area Director, Region VI - Baton Rouge, LA, Area Office; Mirth A. Deshler, Safety Specialist, Region VIII - Denver, CO, Area Office; Brian Hennessy and Bob Chadwick, Safety Specialists, Region IV- Tampa, FL, Area Office.

The following individuals and organizations provided photographs for the report: Larry Falk, Area Director, OSHA, Tampa, FL, Area Office; Anthony Solano, Administrator, Construction and General Laborers, District Council of Chicago and Vicinity Training Facility, Carol Stream, IL; Carl Jones, Apprenticeship Director, Florida West Coast Carpenters (J.A.T.C.), Tampa, FL; Safeway Steel Products; and the Scaffolding, Shoring and Forming Institute.

ABSTRACT

This report is intended to help employers and employees identify and correct hazards related to the most frequently cited OSHA standards found on construction sites throughout the United States. The report also is designed as a resource document for OSHA field personnel. The 100 most cited construction standards for 1991 are presented in the report. The standards cited were checked against similar citations for the years 1987 thru 1990. The relative rankings of the standards cited are similar, affected mostly as a result of the incorporation of new standards. The list was compiled from the OSHA Integrated Management Information System (IMIS). It includes citations by Federal OSHA in the 27 Federal Plan States for employers engaged in construction activities defined by Standard Industrial Classifications (SIC) 15, 16, 17. Citations issued by states operating OSHA approved state plans are not included. A listing of the 100 most cited construction standards related to physical conditions on job sites also is included. This second list does not include citations for so called "paperwork" requirements such as the hazard communications standard ([29 CFR] 1926.59) and safety training and education (1926.21) but does include citations for standards such as hard hats (1926.100), guards for open sided floors (1926.500), etc. The report also examines in detail the top 25 construction hazards relating to physical conditions. Information on the 25 standards includes, among other things: 1) citation and text of the standards; 2) intent and application of the standard; 3) hazards associated with the standard; 4) example case histories related to the standard; 5) suggested abatement of hazardous conditions related to the standard; and 6) additional source materials including interpretation, compliance directives, industry standards, etc., which may aid in the compliance with a given standard.

Keywords: 100 Most Cited; OSHA Standards; Cited Standards; Physical Hazards; Hazard Abatement; Most Cited Construction Standards

Simplified Flow Chart of Contents of Report

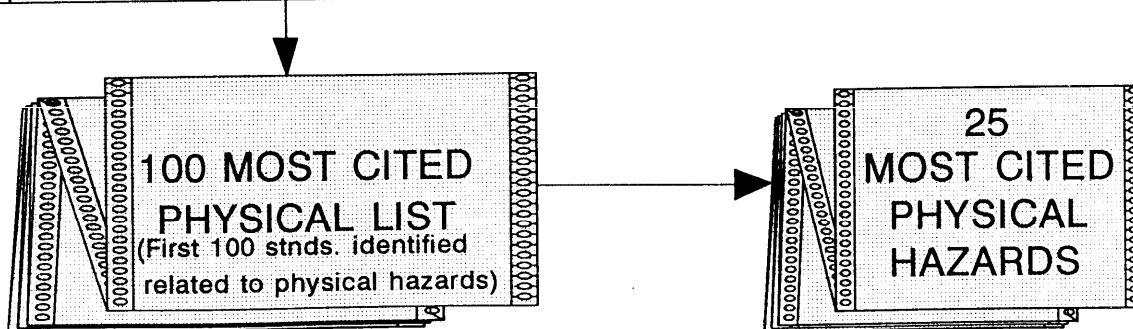
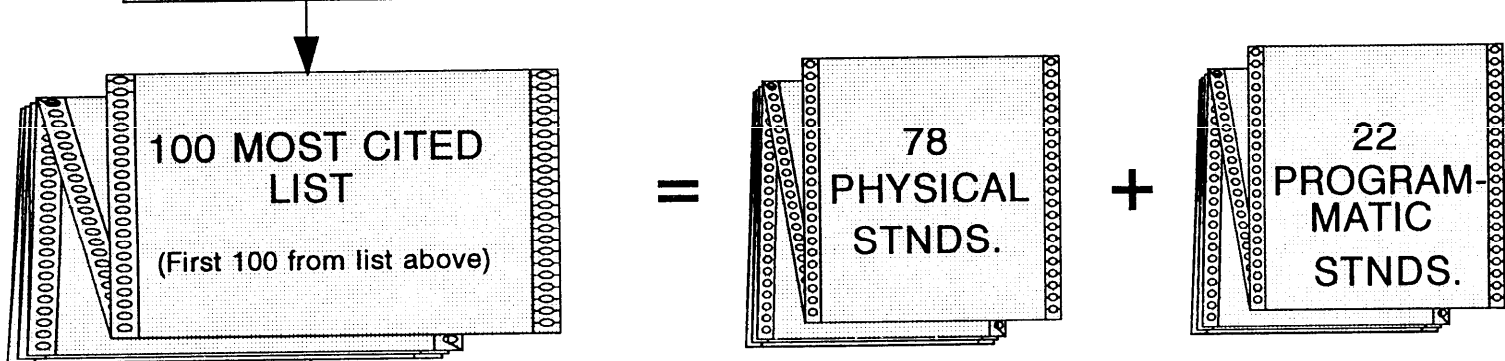
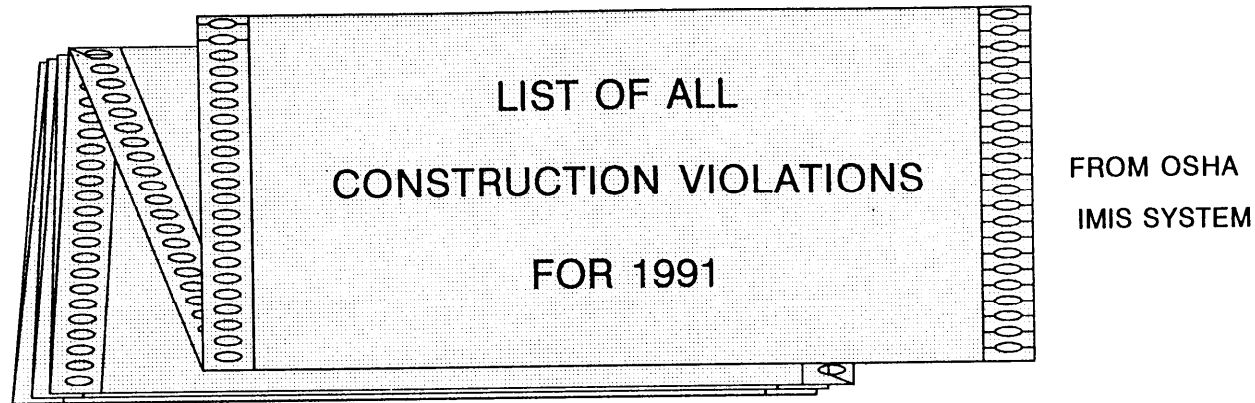

1.0 INTRODUCTION

Fatalities and injuries due to accidents continue to besiege the construction industry. In an effort to help employers, employees and OSHA compliance personnel (CSHO's) identify hazards that are causing accidents, OSHA has compiled listings in this report of the 100 Most Cited Standards in the construction industry. The purposes of the report are to: 1) identify the hazards causing accidents that are associated with the most frequently cited OSHA construction standards; 2) educate the employer, employee and CSHO on hazards found on construction sites and to offer suggestions for eliminating, controlling or mitigating the hazards; 3) notify employers of the types of violations on construction sites that OSHA personnel find most frequently; and 4) provide information in a format that would be readily useable for safety talks, tool box meetings, etc.

The first part of this report contains two lists:

The first list includes the 100 most frequently cited construction standards. The second list of 100 covers only those citations for standards related to physical conditions on a job site. This list does not include citations for so called "paperwork" requirements such as the hazard communications standard (Code of Federal Regulations - Title 29 [CFR 29], 1926.59) and safety training and education (1926.21) but does include citations for standards such as hard hats (1926.100), guards for open sided floors (1926.500), etc. The report refers to the first list as the 100 Most Cited List and the second list as the 100 Most Cited Physical List.

The second part of this report (Chapters 4 and 5) focuses on the top 25 construction hazards from the 100 Most Cited Physical List and serves as a guide to the elimination, control and or mitigation of the physical hazards addressed by the standards cited.

The most cited lists were compiled from the OSHA Integrated Management Information System (IMIS). The IMIS system contains, among other information, a record of all the citations that were issued for each inspection conducted. The lists were generated using 1991 calendar year data for citations issued to employers in the Standard Industrial Classification (SIC) 15, 16, and 17, for construction. Data also are presented for a five-year period that show that the most cited standards

tend to be consistent over a period of years with the rankings altered mostly by the addition of new standards. The data used in this report were drawn from the 27 Federal plan states. Data for states operating OSHA approved state plans are not included.

The 100 Most Cited List contains standards related to both physical and programmatic requirements. For this report a programmatic standard means a standard that could not be identified as the primary physical cause of an accident, but had the programmatic elements been in place and fully implemented might have precluded the hazardous condition(s) that led to the accident from ever existing. Programmatic standards are usually educational or information based such as Hazard Communication standards, recordkeeping requirements, OSHA poster, general safety/health training requirements, or written programs such as respirator, fire prevention plans, etc.

Although this report emphasizes physical hazards and hazard abatement, it cannot be emphasized strongly enough, however, that **a complete and effective safety and health program must contain all the programmatic elements** as well as the elements which address physical hazards. The elements of a thorough and effective jobsite safety program are listed in FIGURE 1-1 (see page 4).

If hazards addressed by the 100 Most Cited Lists do not exist on a particular site one should not conclude that there are no other hazardous conditions that might contribute to an accident. To the contrary, OSHA recognizes that a large percentage of accidents occur due to hazardous conditions that are not covered by specific standards. OSHA standards are only minimum requirements to run a safe and healthful construction site. Therefore, all parties involved with a site must continually identify all hazardous conditions, whether addressed by OSHA standards or not, to achieve a safe and healthful work site.

The 100 Most Cited Physical List ranks the most frequently cited standards that constitute actual physical hazards. This list consists of 78 standards included in the 100 Most Cited List (22 standards from the 100 Most Cited List were programmatic) and 22 other identified physical hazards. Much of the emphasis in this report is placed on controlling physical hazards. A physical hazard is defined in this document as a hazard that can be eliminated, controlled and/or mitigated

by: 1) using some type of hardware, i.e. guard rails to prevent falls, body belt/harness-lanyard-lifeline to mitigate the effects of a fall, flash arrestors in safety cans to prevent a fire/explosion, a fire extinguisher to control or mitigate the effects of an incipient stage fire; or 2) a specific inspection protocol designed to identify defects which can lead to accidents such as the monthly inspections of critical items of crawler, locomotive and truck cranes prescribed by 29 CFR 1926.550(b)(2). A physical hazard can directly cause an accident; conversely, a programmatic violation would not have a direct physical linkage to the direct or primary cause of an accident.

The **GUIDE** in the second part of the report provides detailed information for the first 25 standards on the 100 Most Cited Physical List. The **GUIDE's** format lends itself to safety meetings, tool box talks, etc. Chapter 4 (see page 27) describes the **GUIDE**, its format and use. The **GUIDE** itself can be found in Chapter 5 (see page 31).

Twenty-five physical standards were chosen for the **GUIDE** because all other individual standards were cited less than 0.5 percent of the total number (approximately 62,000) of citations issued to construction contractors in 1991. Citations associated with the 25th Most Cited Physical Standard, for example, account for only one-half of one percent of all construction violations.

FIGURE 1-1

EMPLOYER'S SAFETY AND HEALTH PROGRAM ¹²⁹¹

- A. Management's Commitment and Leadership
 - 1. Policy statement: goals established, issued, and communicated to employees.
 - 2. Program revised annually.
 - 3. Participation in safety meetings, inspections; agenda items in meetings.
 - 4. Commitment of resources is adequate.
 - 5. Safety rules and procedures incorporated into site operations.
 - 6. Management observes safety rules.

- B. Assignment of Responsibility
 - 1. Safety designee on-site, knowledgeable and accountable.
 - 2. Supervisors (including foreman) safety and health responsibilities understood.
 - 3. Employees adhere to safety rules.

- C. Identification and Control of Hazards
 - 1. Periodic site safety inspection program involves supervisors.
 - 2. Preventive controls in-place (PPE, maintenance, engineering controls).
 - 3. Action taken to address hazards.
 - 4. Safety committee, where appropriate.
 - 5. Technical references available.
 - 6. Enforcement procedures by management.

- D. Training and Education
 - 1. Supervisors receive basic training.
 - 2. Specialized training taken where needed.
 - 3. Employee training program exists, is on-going and is effective.

- E. Recordkeeping and Hazard Analysis
 - 1. Records maintained of employees illnesses/injuries and posted.
 - 2. Supervisors perform accident investigations, determine causes and propose corrective action.
 - 3. Injuries, near misses and illnesses are evaluated for trends, similar causes; corrective action initiated.

- F. First Aid and Medical Assistance
 - 1. First-aid supplies and medical services available.
 - 2. Employees informed of medical results.
 - 3. Emergency procedures and training where necessary.

2.0 THE 100 MOST FREQUENTLY CITED OSHA CONSTRUCTION STANDARDS

The following section lists the construction standards most frequently cited in 1991. The information is presented in list form which will be referred to as the 100 Most Cited List. Table 2-1 (see page 7) list the 100 Most Cited Construction Standards in 1991. This table also ranks these standards relative to 1991 for the years 1987 thru 1990. The 100 Most Cited List gives a ranking from the first most frequently cited construction standard to the 100th most cited and provides the standard number, a brief description and its ranking for 1991 relative to the years 1987-1990. The 100 Most Cited list contains standards that are related to both physical and programmatic requirements. A programmatic requirement, for this list, means a standard that could not be identified as the primary physical cause of an accident. Programmatic elements supplement physical hazard standards and if they are fully implemented, may prevent hazardous condition(s) that lead to accidents. Programmatic standards are usually educational or information based and cover injury and illness recordkeeping requirements, Hazard Communication requirements, etc.

No in-depth analysis was conducted to determine the reason(s) for any changes in a standard's rankings in the earlier years. However, the biggest factor for change appears to be the implementation of new standards. For example, the Hazard Communication Standard was not enforced in construction because of legal proceedings until March 1989. The immediate result was that three provisions of the Hazard Communication Standard were ranked #1, #2 & #3 in the 100 Most Cited List starting in 1989. This pattern is consistent for other implemented standards during this period. Generally, except for the new standards previously mentioned, the ranking of the individual standards did not significantly change during the five-year period.

Another list related to the 100 Most Cited List is presented in Table 2-2 (see page 12), which lists the percentage of the total number of (approximately 62,000 violations) cited under each of these standards in 1991.

A chart illustrates the number of PHYSICAL standards vs. the number of PROGRAMMATIC standards cited in the 100 Most Cited List, (see Figure 2-1, page 14). The relatively high number of programmatic violations (22%) might be an indicator of several things such as: 1) a higher degree of noncompliance with the programmatic requirements that are mostly performance oriented; 2) a larger emphasis by CSHO's on programmatic violations; or 3) a higher degree of compliance with specification standards that are mostly addressed by the physical standards. Consequently, the potential number of specification type violations might be fewer on jobsites.

Another chart illustrates from which Subpart, i.e. Subpart N, O, X, etc. each of the standards from the 100 Most Cited List originates, (see Figure 2-2, page 15). This chart directs and assists those who know which Subparts of the standards are the most applicable to his/her operation. With the specific Subparts, the numbers listed for the Subparts of interest can be cross-referenced with the 100 Most Cited List to find the requirements that relate to the operation.

TABLE 2-1

100 MOST CITED CONSTRUCTION STANDARDS AND THEIR RELATIVE RANKING TO 1991

STANDARDS [1926 UNLESS NOTED]	DESCRIPTION	RELATIVE RANKING TO 1991				
		YEARS				
		1991	1990	1989	1988	1987
59(e)(1)	WRITTEN HAZ. COMM. PROGRAM	1	1	1	** ⁽¹⁾	**
59(h)	EMPLOYEE TRAINING – HAZ. COMM.	2	2	2	** ⁽¹⁾	**
59(g)(1)	MSDS FOR HAZ. CHEMICALS	3	3	3	** ⁽¹⁾	**
1903.2(a)(1)	OSHA POSTER	4	4	4	1	2
59(g)(8)	ACCESSIBLE COPIES OF MSDS	5	5	12	** ⁽¹⁾	**
21(b)(2)	SAFETY TRAINING/RECOGNITION OF UNSAFE CONDITIONS	6	7	10	3	6
500(d)(1)	GUARDING OPEN SIDED FLOORS	7	8	8	5	4
100(a)	HEAD PROTECTION	8	10	7	6	5
404(b)(1)(i)	GROUND FAULT PROTECTION	9	6	5	2	1
404(f)(6)	ELECTRICAL GROUNDING	10	9	6	4	3
20(b)(1)	ACCIDENT PREVENTION PROGRAM	11	11	9	7	7
652(a)(1)	PROTECTIVE SYSTEMS FOR TRENCH/EXCAV.	12	15	* ⁽²⁾	*	*
451(d)(10)	GUARDRAIL SPEC. FOR TUBULAR WELDED SCAFFOLDS	13	13	13	9	11
1904.2(a)	OSHA 200 LOG	14	12	11	8	9
28(a)	PPE USED FOR SPECIFIC OPERATION	15	14	14	10	8
1052(c)(1)	STAIR RAIL REQUIRED @ 30"	16	* ⁽³⁾	*	*	*
152(a)(1)	STORMING AND HANDLING FLAMM. OR COMB. LIQUIDS	17	17	15	12	14
25(a)	GENERAL HOUSEKEEPING	18	18	16	11	10
20(b)(2)	ACCIDENT PREVENTION INSPECTIONS	19	15	17	20	49
651(k)(1)	INSPECT. OF PHYSICAL COMPONENTS OF TRENCH/PROTECT. SYSTEM	20	22	* ⁽²⁾	*	*

STANDARDS [1926 UNLESS NOTED]	DESCRIPTION	RELATIVE RANKING TO 1991				
		YEARS				
		1991	1990	1989	1988	1987
451(a)(13)	SAFE ACCESS FOR SCAFFOLDS	21	25	25	27	33
404(b)(1)(ii)	GROUND FAULT CIRCUIT INTERUPTER	22	19	18	13	12
701(b)	GUARDING PROTRUDING STEEL REBARS	23	40	77	*(4)	*
59(e)(1)(i)	LIST OF HAZ. CHEMICALS	24	31	50	** ⁽¹⁾	**
451(a)(4)	SCAFFOLD GUARDING SPEC's.	25	21	19	17	19
651(j)(2)	SPOIL PILE PROTECTION	26	28	27	25	27
350(j)	WELDING AS PER ANSI Z49.1- 1967	27	28	27	25	27
350(a)(9)	SECURING COMPRESSED GAS CYLINDERS	28	27	24	19	20
1910.20(g)(2)	COPY OF 1910.20 STND. AVAILABLE	29	35	20	40	96
102(a)(1)	EYE/FACE PROTECTION	30	26	29	29	28
1910.20(g)(1)(i)	INFORMING OF MEDICAL ACCESS	31	62	40	*(5)	*
1053(b)(1)	LADDER EXTENDED 3' ABOVE LANDING	32	*(3)	*	*	*
500(b)(1)	GUARDING FLOOR OPENING	33	23	22	16	16
651(c)(2)	ACCESS/EGRESS FROM TRENCH/EXCAV.	34	32	*(2)	*	*
1910.20(g)(1)(iii)	RIGHT OF ACCESS TO MEDICAL RECORDS	35	63	43	*(5)	*
403(b)(2)	LISTED, LABELED OR CERT. EQUIP.	36	34	59	68	78
405(a)(2)(ii)(j)	FLEXIBLE CORDS DESIGNED FOR HARD OR EXTRA HARD USAGE	37	33	33	22	21
1910.20(g)(1)(ii)	FLEXIBLE CORDS DESIGNED FOR HARD OR EXTRA HARD USAGE	38	69	46	*(5)	*
405(g)(2)(iv)	STRAIN RELEIF FOR CORDS	39	38	42	38	51
59(f)(5)(i)	LABEL SPEC. - HAZ. CHEMICAL(S)	40	39	45	** ⁽¹⁾	**
304(f)	WOODWORKING TOOLS AS PER ANSI 01-1.1967	41	43	34	23	17
105(a)	SAFETY NETS ABOVE 25'	42	52	48	43	59
300(b)(2)	MACHINE GUARDING - MOVING PARTS	43	42	39	35	29

STANDARDS [1926 UNLESS NOTED]	DESCRIPTION	RELATIVE RANKING TO 1991				
		YEARS				
		1991	1990	1989	1988	1987
59(f)(5)(ii)	LABEL SPEC. – HAZ. COMM.	44	50	65	** ⁽¹⁾	**
405(a)(2)(ii)(e)	PROTECTION TEMPORARY LIGHTING	45	48	38	26	34
500(c)(1)	GUARDING WALL OPENING	46	58	57	44	41
403(i)(2)(i)	ACCESS TO INSTALL. OVER 600 VOLTS	47	45	49	37	36
451(e)(10)	GUARDING SPEC. FOR MOBILE SCAFFOLDS	48	46	41	34	37
451(d)(3)	BRACING OF TUBULAR WELDED SCAFFOLD	49	55	56	48	54
5(a)(1)	GENERAL DUTY CLAUSE	50	30	54	65	73
404(f)(7)(iv)(c)	GROUNDING SPECIFIC TYPES OF EQUIP.	51	53	32	30	31
59(e)(4)	ACCESSIBILITY OF THE WRITTEN HAZ. COMMUNICATION PROGRAM	52	54	** ⁽¹⁾	**	**
50(f)	EMERGENCY NUMBERS POSTED	53	36	26	15	13
1051(a)	ACCESS BY LADDER/STAIRWAY @ CHANGE IN ELEVATION > 19"	54	* ⁽³⁾	*	*	*
405(b)(2)	COVERS FOR PULL BOXES, JUNCTION BOXES, OUTLETS, ETC.	55	61	58	54	47
416(e)(1)	WORN AND FRAYED ELECTRICAL CORDS	56	57	62	55	81
451(a)(2)	LOAD DESIGN FOR SCAFFOLDS	57	60	66	59	61
405(b)(1)	UNUSED OPENING IN BOXES	58	70	74	64	64
550(b)(2)	CRANES – ANSI B30.5-1968	59	65	63	50	52
451(e)(4)	TIGHTLY PLANKED MOBILE SCAFFOLD	60	51	47	42	45
404(a)(2)	REVERSE POLARITY OF CONDUCTORS	61	59	61	45	39
1053(b)(16)	DEFECTIVE PORTABLE LADDER	62	* ⁽³⁾	*	*	*
405(a)(2)(ii)(i)	PROTECTION OF FLEXIBLE CORDS AND CABLES	63	44	37	28	25
1060(a)	TRAINING PROGRAM FOR LADDERS	64	* ⁽³⁾	*	*	*

STANDARDS [1926 UNLESS NOTED]	DESCRIPTION	RELATIVE RANKING TO 1991				
		YEARS				
		1991	1990	1989	1988	1987
602(a)(9)(i)	HORNS ON BIDIRECTIONAL EQUIP.	65	78	83	57	53
500(g)(1)	FALL PROTECTION FOR LOW-PITCHED ROOFS	66	76	85	78	79
50(c)	CERTIFIED FIRST-AID PERSONNEL	67	80	84	73	93
500(b)(8)	GUARDING FLOOR HOLES	68	79	73	60	58
451(a)(14)	EXTENSION OF PLANKING – SCAFFOLD	69	67	93	69	94
405(g)(2)(iii)	ELECTRICAL CORDS LESS THAN NO.12	70	81	78	70	67
556(b)(2)(v)	BELT/LANYARD – AERIAL LIFTS	71	73	80	74	77
150(a)(1)	FIRE PROTECTION PROGRAMS	72	87	69	46	32
451(e)(8)	PLUMB/SOUND BASE FOR MOBILE SCAFFOLDS	73	68	79	72	68
50(d)(1)	ACCESSIBLE FIRST-AID SUPPLIES	74	66	52	36	30
59(e)(1)(ii)	NON-ROUTINE INFORM. – WRITING HAZ. COMM.	75	*(1)	*	**	**
403(b)(1)	ELECT. EQUIP. FREE OF HAZARDS	76	85	*	*	*
500(d)(2)	GUARDING RUNWAY	77	84	72	64	*
451(e)(5)	LADDER/STAIRWAY FOR ACCESS/EGRESS	78	*(3)	99	96	99
602(a)(9)(ii)	BACKUP ALARM PROVIDED	79	74	82	56	46
150(c)(1)(i)	FIRE EXTINGUISHER EVER 300 FT. ² OR 100 FT. TRAVEL	80	49	44	39	38
405(a)(2)(ii)(b)	BRANCH CIRCUIT SPECIFICATIONS	81	92	94	76	75
450(a)(9)	TIMPER MEMBER OF SCAFFOLD FRAMING	82	24	23	18	18
59(f)(5)	LABELING HAZ. CHEMICALS	83	56	70	** ⁽¹⁾	**
59(h)(1)	EMPLOYEE INFORMATION	84	88	71	** ⁽¹⁾	**
404(b)(1)(iii)	ASSURED EQUIP. GROUNDING CONDUCTOR PROGRAM	85	*(5)	*(5)	81	83
500(e)(1)(iv)	RAILING ON STAIRWAY	86 ⁽⁶⁾	29	28	21	22
1052(b)(1)	STAIRWAY TRAVEL WITH EMPTY PANS	87	*	*	*	*
450(a)(10)	SECURING PORTABLE LADDERS	88 ⁽⁶⁾	20	21	14	15

STANDARDS [1926 UNLESS NOTED]	DESCRIPTION	RELATIVE RANKING TO 1991				
		YEARS				
		1991	1990	1989	1988	1987
300(b)(1)	POWER OPERATED TOOL GUARDS	89	91	81	67	65
350(a)(1)	VALVE PROTECTION CAPS	90	75	68	61	66
405(a)(2)(iii)	GUARDING PROTECTING TEMP. WIRING OVER 600 VOLTS	91	*(5)	*(5)	*(5)	*(5)
405(a)(2)ii)(f)	TEMP. LIGHTS FROM ELECT. CORDS	92	97	*	98	72
451(a)(3)	SUPERVISION DURING ERECTION,ETC.	93	*(5)	*(5)	*(5)	*(5)
602(a)(2)(i)	SEAT BELTS FOR EARTHMOVING EQUIP.	94	*(5)	*(5)	95	91
1052(c)(12)	GUARDING FOR STAIRWAY EDGES	95	*(5)	*(5)	*(5)	*(5)
1053(b)(8)	SECURING LADDERS	96	*(3)	*	*	*
59(e)(2)	MULTI-EMPLOYER(S) WORKPLACES – WRITTEN HAZ. COMM. PROVISION	97	83	*(1)	**	**
451(d)(4)	FOUNDATION SPEC. FOR TUBULAR WELDED SCAFFOLD LEGS	98	98	95	*(5)	*(5)
451(a)(10)	SCAFFOLD GRADE PLANKING	99	95	*(5)	*(5)	*(5)
550(a)(6)	ANNUAL INSPECTION OF CRANES	100	93	88	79	76

- (1) Full enforcement of Hazard Communication Standard began in March, 1989.
- (2) Trenching/Excavation Standard became effective on March 5, 1990.
- (3) Ladder/Stairway Standard became effective January, 1991.
- (4) Standard first included in Concrete/Masonry Standard- effective August 15, 1988.
- (5) Particular standard was not one of the 100 most frequently cited in the reference year.
- (6) Standard was part of old Ladder & Stairway Standards and was effectively discontinued January 1991.

TABLE 2-2

**THE MOST FREQUENTLY CITED OSHA CONSTRUCTION STANDARDS IN
1991 BY PERCENTAGE OF TOTAL VIOLATIONS**

RANK⁽¹⁾	STANDARD [1926 UNLESS NOTED]	[PERCENT OF TOTAL] NUMBER OF SPECIFIC STANDARD VIOLATIONS + TOTAL NUMBER CONSTRUCTION VIOLATIONS(91,191)	CUMULATIVE PERCENT [%]
1	59(e)(1)	8.9	8.9
2	59(h)	6.2	15.1
3	59(g)(1)	3.7	18.8
4	1903.2(a)(1)	2.7	21.5
5	59(g)(8)	2.6	24.1
6	21(b)(2)	2.1	26.2
7	500(d)(1)	1.9	28.1
8	100(a)	1.9	30.0
9	404(b)(1)(i)	1.8	31.8
10	404(f)(6)	1.8	33.6
11	20(b)(1)	1.7	35.3
12	652(a)(1)	1.7	37.0
13	451(d)(10)	1.4	38.4
14	1904.2(a)	1.3	39.7
15	28(a)	1.2	40.9
16	1052(c)(1)	1.1	42.0
17	152(a)(1)	1.1	43.1
18	25(a)	1.1	44.2
19	20(b)(2)	1.0	45.0
20	651(k)(1)	1.0	46.0
21	451(a)(13)	0.8	46.8
22	404(b)(1)(ii)	0.8	47.6
23	701(b)	0.8	48.4
24	59(e)(I)(i)	0.7	49.1
25	451(a)(4)	0.7	49.8
26	651(j)(2)	0.7	50.5
27	350(j)	0.6	51.1
28	350(a)(9)	0.6	51.7
29	1910.20(g)(2)	0.6	52.3

RANK⁽¹⁾	STANDARD [1926 UNLESS NOTED]	[PERCENT OF TOTAL] NUMBER OF SPECIFIC STANDARD VIOLATIONS + TOTAL NUMBER CONSTRUCTION VIOLATIONS(91,191)	CUMULATIVE PERCENT [%]
30	102(a)(1)	0.6	52.9
31	1910.20(g)(1)(i)	0.6	53.5
32	1053(b)(1)	0.6	54.1
33	500(b)(1)	0.6	54.7
34	651(c)(2)	0.5	55.2
35	1910.20(g)(1)(iii)	0.5	55.7
36	403(b)(2)	0.5	56.2
37	405(a)(2)(ii)(j)	0.5	56.7
38	1910.20(g)(1)(ii)	0.5	57.2
39	405(g)(2)(iv)	0.5	57.7
40	59(f)(5)(i)	0.5	58.1
41	304(f)	0.4	58.5
42	105(a)	0.4	58.9
43	300(b)(2)	0.4	59.3
44	59(f)(5)(ii)	0.4	59.7
45	405(a)(2)(ii)(e)	0.4	60.1
46	500(c)(1)	0.4	60.5
47	403(i)(2)(i)	0.3	60.9
48	451(e)(10)	0.3	61.2
49	451(d)(3)	0.3	61.5
50	5(a)(1)	0.3	61.8
51	404(f)(7)(iv)(c)	0.3	62.1
52	59(e)(4)	0.3	62.4
53	50(f)	0.3	62.7
54	1051(a)	0.3	63.0
55	405(b)(2)	0.3	63.3
56	416(e)(1)	0.3	63.6
57	451(a)(2)	0.3	63.9
58	405(b)(1)	0.3	64.2
59	550(b)(2)	0.3	64.5
60	451(e)(4)	0.3	64.8
TOTAL			64.8

(1) Includes only those standards \geq 0.3% of the total construction violations in 1991.

Figure 2-1

Frequency of Programatic vs. Physical Violations
100 Most Cited Violation — 1991

Physical
Violations — 78%

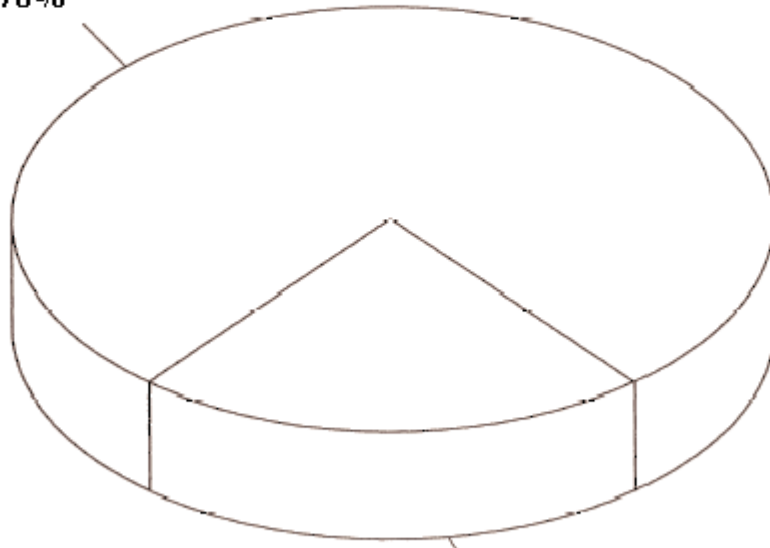

Programatic
Violations — 22%

Figure 2-2

Distribution of the 100 Most Frequently Cited Standards by Subpart

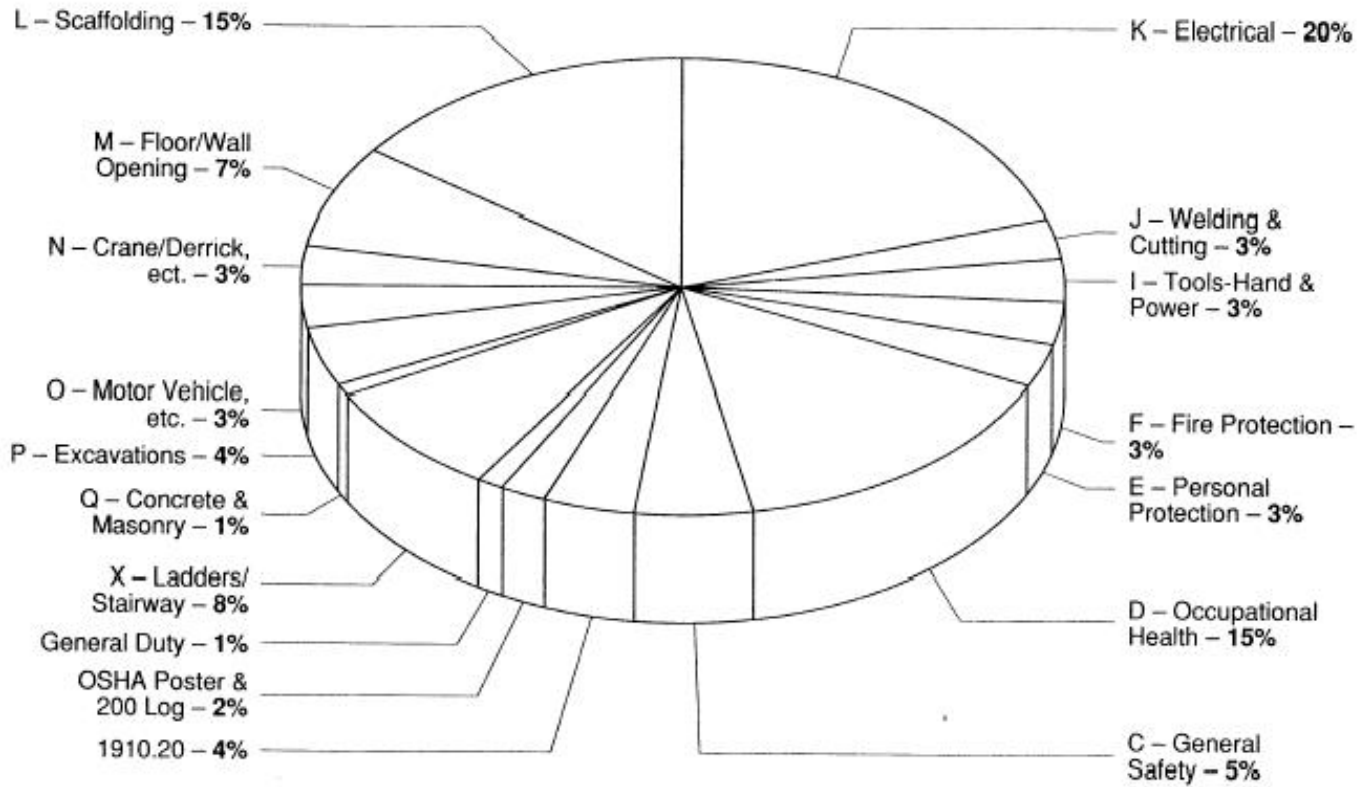

3.0 100 MOST CITED PHYSICAL LIST

The next section presents the 100 Most Cited Physical List. A physical hazard can be the actual cause(s) of an accident. A physical hazard as defined by his report is: 1) one that can be abated (eliminated, controlled and/or mitigated) by using some type of hardware i.e., guard rails to prevent falls; or 2) following a specific inspection protocol designed to identify defects that can lead to accidents such as the monthly inspections of critical items of crawler, locomotive and truck cranes which are prescribed by 1926.550(b)(2).

The 100 Most Cited Physical List presented in Table 3-1 (see page 18) ranks the most frequently cited physical standard from #1 to #100, describes the major activity related to the standard, profiles the standard and gives the standard number.

Other lists help identify which of the 100 standards are related to major subjects and subdivisions of each i.e., major subject - ELECTRICAL; subdivisions - GROUND FAULT PROTECTION, CORD SPECIFICATIONS., etc., see Table 3-2 (page 22) & Table 3-3 (page 23).

TABLE 3-1

**LIST OF THE 100 MOST FREQUENTLY CITED OSHA CONSTRUCTION STANDARDS
RELATED TO PHYSICAL HAZARDS IN 1991**

RANK	DESCRIPTION OF STANDARD		STANDARD (1926.____)
1	Fall Protection	Guarding open sided floors/platforms	500(d)(1)
2	PPE	Head protection from impact, falling or flying objects	100(a)
3	Electrical	Ground fault protection	404(b)(1)(i)
4	Electrical	Path to ground missing or discontinuous	404(f)(6)
5	Trench/Excavation	Protective Systems for trenching/excavation	652(a)(1)
6	Scaffolding	Guardrail specifications for tubular welded frame scaffolds	451(d)(10)
7	PPE	Appropriate PPE used for specific operation	28(a)
8	Ladders/Stairways	Stair rails required @ 30" change of elevation or 4 risers	1052(c)(1)
9	Fire Protection	Approved containers or tanks for storing or handling flammable or combustable liquids.	152(a)(1)
10	General Provisions	General Housekeeping	25(a)
11	Trenching/Excavation	Daily inspection of physical components of trench and protection systems	651(k)(1)
12	Scaffolds	Safe access for all types of scaffolds	451(a)(13)
13	Electrical	Ground fault circuit interrupters (GFCI's)	404(b)(1)(ii)
14	Concrete/Masonry	Guarding protruding steel rebars	701(b)
15	Scaffolds	General requirements for guarding	451(a)(4)
16	Trench/Excavation	Spoil pile protection	651(j)(2)
17	Welding/Cutting	Securing compressed gas cylinders	350(a)(9)
18	Welding/Cutting	Additional rules for welding as per ANSI Z49.1-1967	350(j)
19	PPE	Eye/Face Protection for operations which create exposure	102(a)(1)
20	Fall Protection	Guarding floor openings	500(b)(1)
21	Ladder/stairway	Ladder extended 3' above landings	1053(b)(1)
22	Trench/excavation	Access/Egress from trench/excavation	651(c)(2)
23	Electrical	Listed, labeled or certified equipment used in manner prescribed	403(b)(2)
24	Electrical	Flexible cords designed for hard or extra hard usage	405(a)(2)(ii)(j)
25	Electrical	Strain relief for cords	405(g)(2)(iv)
26	Woodworking Tools	Additional rules for woodworking tools as per ANSI 01.1-1967	304(f)

RANK	DESCRIPTION OF STANDARD		STANDARD (1926._____)
27	Fall Protection	Safety nets above 25' when no other means of fall protection is practical	105(a)
28	Tools	Guarding moving parts of machinery	300(b)(2)
29	Electrical	Protection and grounding for temporary lamps	405(a)(2)(ii)(e)
30	Electrical	Controlled access to installations operating at over 600 volts	403(i)(2)(i)
31	Fall Protection	Guarding wall openings	500(c)(1)
32	Scaffolding	Guarding specifications for mobile scaffolds	451(e)(10)
33	Scaffolding	Bracing tubular welded frame scaffolds	451(d)(3)
34	General Duty	Serious hazard not covered by specific standard	5(a)(1)
35	Electrical	Specific types of equipment or operations where grounding is required	404(f)(7)(iv)(c)
36	Health	Emergency phone numbers posted	50(f)
37	Ladder/Stairway	Access by means of ladder/stairway when no other means provided and change in elevation > 19"	1051(a)
38	Electrical	Covering provided for pull boxes, junction boxes, outlets, etc.	405(b)(2)
39	Electrical	Worn or frayed electrical cords	416(e)(1)
40	Scaffolding	Sound, rigid, and load capable footings or anchorages for all types of scaffolds	451(a)(2)
41	Electrical	Unused opening in boxes must be closed and conductors entering boxes must be protected from abrasion.	405(b)(1)
42	Cranes/Derricks	All crawler, truck, or locomotive cranes meet ANSI B30.5-1968	550(b)(2)
43	Scaffolding	Tightly planked mobile scaffolds	451(e)(4)
44	Electrical	Reverse polarity of conductors	404(a)(2)
45	Ladders/Stairways	Defective portable ladders tagged and taken out-of-service	1053(b)(16)
46	Electrical	Protecting flexible cords and cables from damage	405(a)(2)(ii)(i)
47	Matl. Handling Equip.	Horns provided on bi-directional equipment	602(a)(9)(i)
48	Health	Certified first-aid trained personnel when treatment is not readily available	50(c)
49	Fall Protection	Components of a fall protection system for low-pitched roof work	500(g)(1)
50	Fall Protection	Guarding floor holes	500(b)(8)
51	Scaffolding	Specifications for extension of planking beyond supports	451(a)(14)
52	Fire	Provide for firefighting equipment and a fire protection program.	150(a)(1)
53	Electrical	Splicing and tapping electrical cords less than No. 12	405(g)(2)(iii)

RANK	DESCRIPTION OF STANDARD		STANDARD (1926.____)
54	Fall Protection	Body belt and lanyard while working from aerial lift	556(b)(2)(v)
55	Scaffolding	Plumb and sound base for mobile scaffold – casters locked	451(e)(8)
56	Health	Accessible first-aid supplies approved by consulting physician	50(d)(1)
57	Electrical	Electrical equipment is free of hazards as determined by specifications.	403(b)(1)
58	Fall Protection	Guarding runways	500(d)(2)
59	Scaffolding	Ladder/stairway affixed or built-in to mobile scaffold for access/egress	451(e)(5)
60	Matl. Handling Equip.	Backup alarm or signalman provided when operating in reverse	602(a)(9)(ii)
61	Fire	Fire extinguisher for every 3000 sq. ft. of protected building area and 1000 feet of travel	150(c)(1)(i)
62	Electrical	Branch circuit specifications	405(a)(2)(ii)(b)
63	Ladders/Stairways	Ladders extended 3' above landing	450(a)(9)
64	Electrical	Assured equipment grounding conductor program	404(b)(1)(iii)
65	Ladders/Stairways	Stair rail and handrail specifications	500(e)(1)(iv)
66	Ladders/Stairways	No travel on stairways with empty pans	1052(b)(1)
67	Ladders/Stairways	Securing portable ladders	450(a)(10)
68	Tools	Power operated tool guards	300(b)(1)
69	Welding/Cutting	Valve protection caps in-place and secure	350(a)(1)
70	Electrical	Guarding provided for temporary wiring operating over 600 volts	405(a)(2)(iii)
71	Scaffolding	Competent person supervision during erection, dismantling, etc.	451(a)(3)
72	Electrical	Temporary lights suspended from electrical conductor cords	405(a)(2)(ii)(f)
73	Matl. Handling Equip.	Seat belts for all earth moving equipment	602(a)(2)(i)
74	Ladders/Stairways	Guarding stairway edges and landings	1052(c)(12)
75	Ladders/Stairways	Siting and securing ladders	1053(b)(8)
76	Scaffolding	Scaffold grade planking or equivalent	451(a)(10)
77	Scaffolding	Foundation specifications for tubular welded frame scaffold Legs	451(d)(4)
78	Cranes/Derricks	Annual inspection of cranes/derricks	550(a)(6)
79	Cranes/Derricks	Barricading the swing radius of cranes/derricks	550(a)(9)
80	Fire	Specifications for fire extinguisher on each floor of multi-story Structure	150(c)(1)(iv)

RANK	DESCRIPTION OF STANDARD		STANDARD (1926._____)
81	Ladders/Stairways	Stairrail specifications	500(e)(1)(iii)
82	Scaffolding	Tie specifications for tubular welded frame scaffolds	451(d)(7)
83	Fire	Inspection of fire extinguisher in accordance with NFPA 10A-1970	150(c)(1)(viii)
84	Electrical	Deenergizing or guarding electrical circuits which are in proximity of employees	416(a)(1)
85	Scaffolding	Immediate replacement or repair of any damaged or defective components of scaffolding systems	451(a)(8)
86	Trenching/Excavating	High-visibility garments when exposed to vehicular traffic	651(d)
87	Health	Common drinking cup	51(a)(4)
88	Fire	“NO SMOKING” signs posted in service and refueling areas	152(g)(9)
89	Fire	Fire extinguisher for cranes/derricks	550(a)(14)(i)
90	Ladders/Stairways	Swing radius specifications for doors/gates which open on to a stairway or landing	1052(a)(4)
91	Scaffolding	Lifeline support on suspension scaffolds	451(i)(8)
92	Scaffolding	Specifications for catch platform for “steep-slope” roofs	451(u)(3)
93	Matl. Handling Equip.	Industrial trucks (fork lifts) meet ANSI B56.1-1969	602(c)(1)(vi)
94	Motor Vehicles	Specifications for using vehicles with obstructed views to rear	601(b)(4)
95	Fire	Fire extinguisher specifications for locations near flammable/combustible materials	150(c)(1)(vi)
96	Welding/Cutting	Regulators/gauges kept in proper working order	350(h)
97	Cranes/Derricks	Competent person to inspect crane to identify defects prior to use	550(a)(5)
98	Fire	Periodic inspection of firefighting equipment	150(a)(4)
99	Fire	Storing liquefied petroleum gases in buildings	153(j)
100	Scaffolding	Locking or pinning legs to prevent uplift	451(d)(6)

TABLE 3-2**GROUPING BY SUBJECT OF 100 MOST CITED PHYSICAL STANDARDS**

SUBJECT	RELATED RANK NUMBERS FROM TABLE 3-1⁽¹⁾[PERCENT⁽²⁾]
ELECTRICAL	3,4,13,23,24,25,29,30,35,38,39,41,44,46,53,57,62,64,70,72,84 [21%]
SCAFFOLDING	6,12,15,32,33,40,43,51,55,59,71,76,77,82,83,91,92,100 [18%]
LADDER/STAIRWAY	8,21,37,45,63,65,66,67,74,75,81,90 [12%]
FIRE	9,52,61,80,83,88,89,95,98,99, [10%]
PPE	2,7,19 [3%]
TRENCH/EXCAVATION	5,11,16,22,86 [5%]
FALL PROTECTION	1,20,27,31,49,50,54,58 [8%]
CRANES/DERRICKS	42,78,79,97 [4%]
WELDING/CUTTING	17,18,69,96 [4%]
MATERIAL HANDLING EQUIPMENT	47,60,73,93 [4%]
HEALTH	36,48,56,87 [4%]
MISCELLANEOUS	10,14,26,28,34,68,94 [7%]

(1) Refer to the ranking of individual standards listed in TABLE 3-1, i.e. "Electrical - #13, GFCI requirement".

(2) PERCENT – Sum of individual standards per subject divided by 100

TABLE 3-3

COMBINED STANDARDS BY SUBJECT MATTER FROM THE LIST 100 PHYSICAL STANDARDS IN 1991

MAJOR SUBJECT COMBINED STANDARD TITLE	#⁽¹⁾	DESCRIPTION OF EACH STANDARD FOR COMPARISON
<u>ELECTRICAL</u>		
GROUND FAULT PROTECTION	3 13 64	Ground fault protection Ground fault circuit interrupters (GFCI's) Assured equipment grounding conductor program
CORD SPECIFICATIONS	25 24 46	Strain relief for cords Flexible cords designed for hard or extra hard usage Flexible cords and cables made suitable for specific conditions
SPECIFICATIONS FOR TEMPORARY LIGHTING	29 72	Protection and grounding for temporary lamps. Temporary lights suspended from electrical conductor cords
COVERED FOR BOXES, UNUSED OPENING, ETC	38 41	Covering provided for pull boxes, junction boxes, outlets, etc. Unused opening in boxes must be closed and conductors entering boxes must be protected from abrasion.
CONTROLLED ACCESS AND GUARDING OF EQUIPMENT OPERATING >600 VOLTS	30 70	Controlled access to installations operating at over 600 volts. Guarding provided for temporary wiring operating over 600 volts.
		<u>STAND ALONE STANDARDS</u> 4,23,35,39,44,53,57,62,84

<u>MAJOR SUBJECT COMBINED STANDARD TITLE</u>	#⁽¹⁾	DESCRIPTION OF EACH STANDARD FOR COMPARISON
<p><u>SCAFFOLDING</u></p> <p>GUARDING SPECIFICATIONS</p> <p>ACCESS</p> <p>FOUNDATION SPECIFICATIONS</p>	<p>6 15 32</p> <p>12 59</p> <p>40 55 77 100</p>	<p>Guardrail specifications for tubular welded frame scaffolds General requirements for guarding Guarding specifications for mobile scaffolds</p> <p>Safe access for all types of scaffolds Ladder/stairway affixed or built-in to mobile scaffold for access/egress</p> <p>Sound, rigid, and load capable footings or anchorages for all types of scaffolds Plumb and sound base for mobile scaffold – casters locked</p> <p>Foundation specifications for tubular welded frame scaffold legs Locking or pinning legs to prevent uplift</p> <p><u>STAND ALONE STANDARDS</u> 32,43,51,71,76,82,85,91,92</p>
<p><u>LADDER/STAIRWAY</u></p> <p>STAIR RAIL REQUIREMENTS</p> <p>DEFECTIVE LADDERS</p> <p>LADDER ERECTION</p>	<p>8 74</p> <p>45</p> <p>75 21</p>	<p>Stair rails required @ 30” change of elevation or 4 risers Guarding or stairway edges and landings</p> <p>Defective portable ladders tagged and taken out-of-service</p> <p>Siting and securing ladders Ladders extended 3’ above landings</p> <p><u>STAND ALONE STANDARDS</u> 37,63,65,66,67,81,90</p>

MAJOR SUBJECT COMBINED STANDARD TITLE	#⁽¹⁾	DESCRIPTION OF EACH STANDARD FOR COMPARISON
<u>FIRE PROTECTION</u> FIRE EXTINGUISHER	61 80 83 89 95	Fire extinguisher for every 3000 sq. ft. of protected building area and 100 ft. of travel Specifications for fire extinguisher on each floor of multi-story structure Inspection of fire extinguisher in accordance with NFPA 10A-1970 Fire extinguisher for cranes/derricks Fire extinguisher specifications for locations near flammable/combustible materials <u>STAND ALONE STANDARDS</u> 9,52,88,98,99
<u>PPE</u> SPECIFIC WEAR	2 7 19	Head protection from impact, falling or flying objects Appropriate PPE used for specific operation Eye/face protection for operations which create exposure <u>STAND ALONE STANDARDS</u> NONE
<u>TRENCHING/EXCAVATION</u>		<u>STAND ALONE STANDARDS</u> 5,11,16,22,86
<u>FALL PROTECTION</u> SPECIFICATIONS FOR VARIOUS WORK SURFACES	1 20 31 50 58	Guards for open sided floors/platforms Guarding floor openings Guarding wall openings Guarding floor holes Guarding runways <u>STAND ALONE STANDARDS</u> 27,49,54
<u>CRANES/DERRICKS</u> INSPECTION REQUIREMENTS	42 78 97	REF. ONLY – All crawler, truck, or locomotive cranes meet ANSI B30.5-1968 Annual inspection of cranes/derricks Competent person to inspect crane to identify defects prior to use <u>STAND ALONE STANDARDS</u> 42,79

<u>MAJOR SUBJECT COMBINED STANDARD TITLE</u>	#⁽¹⁾	DESCRIPTION OF EACH STANDARD FOR COMPARISON
<u>WELDING/CUTTING</u> CYLINDERS	17 69	Securing compressed gas cylinders Valve protection caps in-place and secure <u>STAND ALONE STANDARDS</u> 18,96
<u>MATERIAL HANDLING EQUIPMENT</u> SAFE MOVEMENT	47 60	Horns provided on bidirectional equipment Backup alarm or signalman provided when operating in reverse <u>STAND ALONE STANDARDS</u> 73,93
<u>HEALTH</u> EMERGENCY RELATED	48 56 36	Certified first-aid trained personnel when treatment is not readily available Accessible first-aid supplies approved by consulting physician Emergency phone numbers posted <u>STAND ALONE STANDARDS</u> 87
<u>MISCELLANEOUS</u> STAND ALONE STANDARDS	10 14 26 28 34 68 94	General Housekeeping Guarding protruding steel rebars Additional rules for woodworking tools as per ANSI 01.1-1967. Guarding moving parts of machinery General Duty Power operated tool guards Specifications for using vehicles with obstructed views to rear

(1) Refers to the ranking number of individual standards listed in TABLE 3-1, i.e. "Electrical - #13 Ground Fault Circuit Interrupters".

4.0 FORMAT AND USE OF GUIDE

The following chapter describes the **GUIDE**. The format discusses the headings for each particular **GUIDE** Sheet.

4.1 USE OF GUIDE

The **GUIDE** consist of 25 user-friendly data sheets covering the first 25 standards from the 100 Most Cited Physical List. Each two page **GUIDE** is accompanied by photographs or illustrations depicting acceptable and unacceptable conditions related to the standard. Captions describe the photograph or illustration and identify an acceptable or unacceptable condition. The following key specifies an acceptable or unacceptable condition:

VIOLATION **IN-COMPLIANCE** Acceptable condition

VIOLATION IN-COMPLIANCE Unacceptable condition

Note: The photographs and illustrations may identify other conditions than those addressed by the particular **GUIDE**. The caption, however, only mentions the situation germane to that **GUIDE**.

These **GUIDE** are intended to be usable information or a training source for safety talks, tool box meetings, etc.

Much of the information contained in the **GUIDE SHEETS** is taken from OSHA field personnel with many years of field experience. The **GUIDE**, therefore, gives the contractor some insight into the types of conditions the OSHA CSHO observes on the Job-site,

Statistical dales presented in the individual **GUIDE** related to fatalities were taken from an OSHA report (see Section 5.3 REFERENCES - [10]) developed from OSHA accident investigation data. Data presented related to injuries came from an OSHA report (see Section 5.3 REFERENCES - [6]) which was based on the Bureau of Labor Statistics - Supplementary Data System (SDS).

4.2 FORMAT

This section identifies information and sources, where applicable, that are found in each the sub-headings in the individual **GUIDE** in Chapter 5.

Heading

Gives the ranking of the particular standard or **GUIDE** on the 100 Most Cited Physical List, the standard number and a brief key word description of the standard.

Rule

Quotes the standard.

Intent

States the intent and/or the purpose of the standard. For example, a fall prevention system may be required on a scaffold to prevent falls from elevations. The intent of a corresponding standard might be to specify the construction of a guard rail system. While this sub-heading specifies the requirements of the standard, it might also include information on: 1) the history of a particular hazard related to the standard, i.e., a certain number of fatal/lost-time falls from scaffolds over a given period of time; and 2) the theory or operation or equipment, loss prevention technique, etc. which might be associated with the standard.

Hazards

Lists the most commonplace hazards associated with the standard. Additionally, lists common probable injuries identified with the listed hazard. **NOTE:** No attempt is made to list all hazards associated with the specific standard because of the numerous hazardous conditions and situations that each standard may cover. The employer must first evaluate the situation/condition and identify all the hazards. Secondly, the employer must decide which standards apply and then take the appropriate actions required by the standard to abate the hazards.

(Among Other) Suggested Abatements

Lists at least one common and sometimes obvious abatement method to correct the hazard(s) associated with the particular standard. **NOTE:** As above, there may be many acceptable means of abatement for hazard(s) related to the standard. Also, the abatement methods listed **MAY NOT** cover the situation/condition at any given jobsite. Therefore, it is incumbent upon the employer to evaluate the operation to insure the abatement is adequate to control or eliminate the hazard.

The employer must identify, control or eliminate all hazards (29 CFR 1926.20 & .21) on the jobsite through an effective and implemented safety program. The elements of a thorough jobsite safety program are listed in FIGURE 1-1 - EMPLOYER'S SAFETY AND HEALTH PROGRAM^[29] (see page 4). The elements listed in FIGURE 1-1 apply to controlling any hazard on any jobsite including those listed in this report. Therefore, these common abatement methods are not listed on each **GUIDE**, but must be followed to achieve a safe and healthful work place.

Selected Case Histories

Lists at least one fatal/catastrophic accident where the particular standard was cited and was directly related to the cause(s) of the accident. The accident cases were extracted from the OSHA IMIS System which contains accident information in an abstract format from the OSHA-1 70 Form (codified form used by OSHA CSHO's when investigating fatal or catastrophic accident) and from various OSHA Fatal Facts Accident Reports. This section offers a reader or employee(s) at safety meetings/tool box talks an idea of possible consequences if the requirements of the standard are not followed.

Comments

Lists at least one comment related to the standard, giving information such as the number of times the standard was cited during OSHA accident/catastrophe investigations, common observations from OSHA field personnel related to the standard, common conditions found in the field that do not meet the requirements of the standard, etc.

Additional Documents to Aid in Compliance

Lists other documents that are directly related to the particular standard and provides supplement information to the employer, employee or CSHO. However, it is important to understand that other industry/operational documents may be used to support OSHA violations. The other listed non-OSHA documents carry the same legal impact if they are incorporated by reference listed in the OSHA standards with a specific standard number such as ANSI 249.1 - 1967 Safety in Welding and Cutting, which is listed as OSHA standard 1926.3500). Other documents may be used as criterion documents to illustrate industry practice to support a "General Duty Clause 5(a)(1)" violation.

Additionally all pertinent current and historic OSHA documents listed in the OSHA Computer Information System (OCIS) including directives, compliance letters, individual letters of interpretation, etc. have been listed by date with a synopsis of the associated information to help interested parties research the standard.

Bracketed numbers, i.e. [29], refer to corresponding documents listed in APPENDIX B-REFERENCES.

Photographs, Illustrations and Other Documents

This section uses photographs and/or illustrations to show some common acceptable and unacceptable situations/conditions found at construction sites related to the standard. Additionally, some of the GUIDE Sheets include items such as checklists and other Agency documents.

5.0 GUIDE FOR THE ABATEMENT OF THE TOP 25 MOST CITED PHYSICAL HAZARDS

The **GUIDE** consists of the following: 1) Section 5.1 contains the top 25 most frequently cited physical standards or hazards from the 100 Physical List presented in TABLE 3-1 (see page 18), each **GUIDE** is presented as an individual information/data source for each standard; 2) Section 5.2 consists of two tables related to construction specifications for guardrails and toeboards that are common for every one of the individual **GUIDE** Sheets; and 3) Section 5.8 contains a list of additional sources of further OSHA and industry information.

5.1 THE TOP 25 GUIDE SHEETS

The following section presents individual **GUIDE** Sheets to help employers, employees and OSHA personnel identify and abate the 25 most frequently cited physical hazards on construction sites.

<u>RANK IN FREQUENCY CITED</u>	1926.	
#1	500(d)(1)	GUARDDRAILS NOT PROVIDED FOR OPEN-SIDED FLOORS OR PLATFORMS

RULE: *Every open-sided floor or platform 6 feet or more above adjacent floor or ground level shall be guarded by a standard ramp, or the equivalent, as specified in paragraph (f)(1) of this section, on all open sides, except where there is an entrance to a ramp, stairway, or fix ladder. The railing shall be provided with a standard toeboard wherever, beneath the open sides, persons can pass, or there is moving machinery, or there is equipment with which falling materials could create a hazard.*

INTENT:

Falls from elevations are the leading cause of fatalities in the construction industry. From 1985-1989, 33% of all construction fatalities [10] resulted from a fall from an elevation. One hundred-seventeen fatalities occurred when employees fell from open sided doors and through floor openings. This standard specifies that guarding must be provided for all open-sided floors and platforms 6 feet or more in height. It also specifies minimum requirement for the type of guarding. Paragraph (f) of the same section species the requirement of a standard guardrail system. TABLE 5.2-1 lists guardrail specifications for various materials. Where there is an open-sided floor/platform and there is a potential for a person to pass or a hazard is presented by machinery, toeboards are required. The intent is to contain any materials near the edge from inadvertently getting pushed over the edge where they may strike persons or machinery below. TABLE 5.2-2 lists specifications for toeboards.

HAZARDS :

- Falls from elevations: probable injuries range from death to fractures; Fall from lower elevations such as 4-6 feet have caused serious lost-time accident and occasionally have been the cause of fatalities.
- Struck by: the lack of material containment (toeboards) has caused both fatalities and lost-time accidents when falling materials have struck employees below.

(AMONG OTHER) SUGGESTED ABATEMENTS :

- Whenever an employee must work at any elevated location, ask the questions: 1) Are they protected from a fall? and 2) What measures must be taken to protect the employee at the elevated work location?
- Fall prevention systems such as standard guardrail systems provide more positive means of protection than fall protection systems such as a bodybelt/harness-lanyard-lifeline combination, except when workers are suspended, i.e. working on suspended scaffolds, work platforms, etc.
- Construct/maintain all guardrail systems according to OSHA requirements.
- An acceptable method to preclude the use of toeboards, would be to determine the fall radius of materials on an open-sided door/platform. Place positive physical barrier outside the potential fall radius to keep workers and machines outside the danger zone.

SELECTED CASE HISTORIES :

An employee taking measurements was killed when he fell backwards from an unguarded balcony to the concrete 9'6" below.

COMMENTS :

- Falls from elevations accounted for 14% of all lost-time accidents[6].
- This standard was cited in 103 fatality/catastrophe inspections conducted by OSHA over a 4 year period.

ADDITIONAL DOCUMENTS TO AID IN COMPLIANCE :

[1] Section 500 & Steel Erection - 750 & 752(k); [11]; [12]; [13]; [26] Part - 701(f)(2) - Concrete and Masonry Const.

OSHA COMPLIANCE LETTER

Date 5/22/84; From-Directorate of Field Operations to Regional Administrators; Synopsis - Clarification of 1926.750(b)(1)(iii) stating that ½ " wire rope or equivalent safety railing must be used around temporary planked or temporary metal-decked doom during steel erection operation. Raging also must be provided at leading edge if spreading stops for any significant time period. ½ " synthetic or fiber rope would not be acceptable as a required safety railing for steel erection operations.

OSHA COMPLIANCE LETTER

Date 1/13/81; From-Assistant Secretary to Int. Union of Bricklayers & Allied Craftsmen; Synopses - Standards 1926.28, 1926.104, 1926.105 & 1926.500(d)(1) do not apply to overhand bricklaying operations.

OSHA COMPLIANCE LETTER

Date 2/13/86; From-Directorate of Field Operations to Individual Company; Synopses - When structural steel assembly including decking has been completed and other trades are working on the deck while concrete is being poured on the deck, the door must be guarded in accordance with 1926.500(d)(1).

PHOTOGRAPHS, ILLUSTRATIONS and OTHER DOCUMENTS



VIOLATION IN-COMPLIANCE

Exposure to open-sided floor

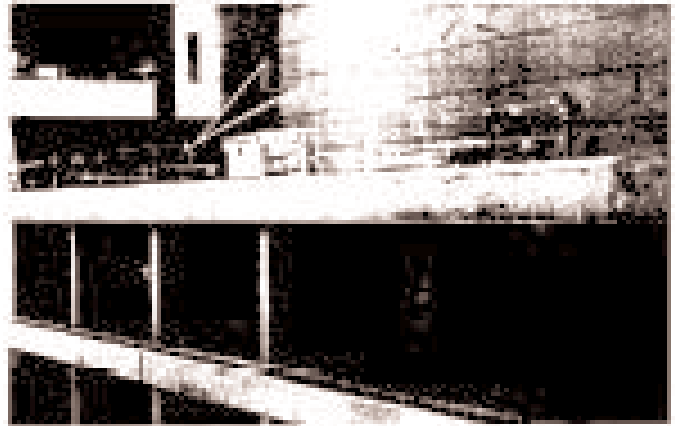

VIOLATION IN-COMPLIANCE

Properly erected wire rope perimeter guardrail system.

NOTE: The high visibility tape on wire rope (arrow) on top floor makes the guardrail easier for the employees to see.



VIOLATION IN-COMPLIANCE

Too much sag in the wire rope (arrows) guard rails



VIOLATION IN-COMPLIANCE

Properly erected wooden guardrail system for platform.

NOTE: The top erection floor has a properly erected wire rope guardrail system.

<u>RANK IN FREQUENCY CITED</u>	1926.	HEAD PROTECTION FROM IMPACT, FALLING OR FLYING OBJECTS AND ELECTRICAL BURNS
#2	100(a)	

RULE: *Employees working in areas where there is a possible danger of head injury from impact, or from falling or flying objects, or from electrical shock and burns shall be protected by protective helmets.*

INTENT

Thousands of head injuries each year occur in the construction industry. This standard requires employees to wear "hard hats" to mitigate or lessen the effects of being struck by an object, accidentally striking their head against an object or making contact with an energized electrical line. It needs to be emphasized that the standard is not just for employees that work at sites where there is a possibility of falling objects striking them in the head, in workers on lower levels of a multi-story building project which are exposed to falling materials such as hand tool, bolts, nuts, etc. But it is also intended for employees who work in the vicinity of an operation that is found on a construction site. These type of energy releases are common to almost all construction operation and are not predictable. Almost all construction operations involve the potential of falling and flying objects, and, therefore, employees must wear head protection. Additionally many impact hazards exist. For instance, iron workers are constantly exposed to striking their heads on structural steel during erection, carpenters strike their heads on temporary framing lumber as they move through a building, etc. Employees that work in the vicinity of electrical conductors are exposed to potential shocks and burns to the head should they contact an uninsulated conductor.

HARZARDS

Struck by: injuries ranging from death to major concussion or trauma to minor abrasions; electrocution.

(AMONG OTHER) SUGGESTED ABATEMENT(S):

- Emphasize that the wearing of hard hats is not only for those employees that are exposed to falling objects, but it is also for employees exposed to the other types or hazards.
- Focus on the wearing of hard hats during site inspections. Check hard hats to insure their integrity is not compromised. Metal hard hats are electrical conductors and do not meet the requirement of OSHA and ANSI.
- A formal management discipline program may need to be utilized for those employees who after repeated warnings either refuse or "forget" to wear their hard hats where required.

SELECTED CASE HISTORIES

- An employee was standing under a suspended scaffold that was hosting a workman and 3 sections of ladder. Sections of the ladder became unlashd and fell ≈ 50 feet striking the employee in the skull. The employee, who was not wearing any head protection died from injuries received.
- Two employees were using a wire rope to winch a wooden tool shed onto a flat bed trailer. The wire rope broke, snapped back struck one of the employees in the top of the head, killing him. The employee was not wearing a hard hat.
- Employees were using a 5-ton winch to pull a 10-foot section of a 600 lb. grain spout through a vent hole when the spout became wedged. Employees were attempting to use pry bars to free the spout that was still under tension from the winch when the spout popped free, striking an employee in the head. No head protection was provided.

COMMENTS

1. OSHA [6] found that in a four year period from 1985 to 1988, 3.2% (11,685) of all construction lost time accidents in 10 states were related to head injuries.
2. All lost-time accidents involving head injuries do not result from being struck by falling and flying objects. OSHA [6] found that the head was the "Part of Body" injured in 9% (7125) of the "Struck By" (falling and flying object) type injuries. This compared to 5% (1440) for "Struck Against", (impact) type injuries; in other words, impacts are the cause of about 17% of all lost time head injuries.
3. This standard was cited in 142 fatality/catastrophe inspections by OSHA in a five year period.

ADDITIONAL DOCUMENTS TO AID IN COMPLIANCE

[1] Section 100 (b)& (c); [7]*; [8]*; [9], [25].

*- Referenced in 29 CFR 1926- Construction Standards

OSHA CLARIFIICATION LETTER

Date 8/23/83 – Synopsis – The employer must determine which employees face possible head injuries and must wear appropriate head protection. OSHA has no exhaustive guidelines for determining when head protection must be worn. A case-by-case analysis must be performed by the employer.

OSHA CLARIFICATION LETTER

Date 7/22/92; From Directorate of Compliance to IBEW Business Manager – Synopsis – Wearing of hard hats with bill to the rear would not meet 1926.100(a) & (b) unless manufacturer certifies that this practice meets ANSI Z89.1-1969. ANSI test and certifies hard hats with bills facing forward.

PHOTOGRAPHS, ILLUSTRATIONS and OTHER DOCUMENTS



VIOLATION **IN-COMPLIANCE**

Hardhat meets OSHA and ANSI Z89.1-1969, Safety Requirements for Industrial Head Protection

VIOLATION IN-COMPLIANCE

Work is in progress on top of scaffold. The workers drilling below scaffold are exposed to being struck by falling materials. There is a need for head protection which is not provided by the soft hats shown



VIOLATION IN-COMPLIANCE

The inspector on the ground (arrow) is exposed to falling materials. Therefore, head protection is required for him. The carpenters would most likely not be exposed to falling materials in this situation. However, a flying material hazard may exist and the operation must be evaluated to determine if head protection is required. NOTE: Fall hazards do exist at the perimeter and at the floor openings. Also, an improperly constructed ladder is being used.



<u>RANK IN FREQUENCY CITED</u>	1926.	
#3	404(b)(1)(i)	GROUND FAULT PROTECTION NOT PROVIDED

RULE: *General. The employer shall use either ground fault circuit interrupters as specified in paragraph (b)(1)(III) of this section or an assured equipment grounding conductor program as specified in paragraph (b)(1)(III) of this section to protect employees on construction sites. These requirements are in addition to any other requirements for equipment grounding conductors.*

INTENT:

Due to the dynamic, rugged nature of a typical construction site, electrical equipment, especially tools and extension cords are much more susceptible to deterioration due to "normal" use and sometimes abuse. When the deterioration occurs, sometimes insulation cracks or breaks exposing bare energized conductors, stress and strain may cause terminal screws to loosen resulting in one conductor short-circuiting another, etc.. The result can be that fault current is generated which may be directed through an employee's body to ground. Wet conditions often found at construction sites, greatly increase this hazard. This standard offers the employer two additional methods beyond the required equipment grounding conductor, to reduce and/or eliminate fault current which might be generated in any electrical system or tool during use. One means is to provide ground fault circuit interrupters (GFCI's) in all temporary receptacle outlets rated 120 volt single phase, 15&20 amps. This is essentially a hardware requirement. The GFCI continually monitors and compares the amount of current going to an electrical tool or piece of equipment against the amount of current returning along the "grounded neutral". If the differential in current (amount going to the tool vs. amount coming from tool) is more than 5 milliamps, the GFCI is designed to trip in about 1/40 of a second. The other option is to establish and fully implement an **Assured Equipment Grounding Conductor Program (AEGCP)**. This program relies on daily visual inspections and periodic (three months maximum for temporary cords and cords exposed to damage, six months for fixed cords not exposed) test inspections. Additionally, the AEGCP requires a written description, a competent person to implement the program and a record of the periodic tests.

HAZARDS:

Fatal electrocutions; Electrical burns ranging from critical to minor; Fire; Explosion; Electric shock has been the initiator of other type hazards, i.e. electrical shocks have been the initiating cause of employees falling from elevated work surfaces, electrical shocks have caused employees to lose control of hand held equipment which in turn has struck and injured other employees in the immediate work area, etc.

(AMONG OTHER) SUGGESTED ABATEMENTS:

- Instruct employees to visually inspect all electrical equipment prior to use. Any defects such as frayed cords; missing ground prongs, cracked tool casing, etc. should be corrected by taking the tool out-of-service. Apply a warning tag to the tool and do not allow it to be used until the problem has been corrected.
- Frequently trip GFCI's while test tool is operating to insure GFCI is operating correctly.
- Use double insulated tools. Double insulated tools protect the user from fault currents which might energize the case of the tool or equipment.

SELECTED CASE HISTORIES:

A journeyman HVAC worker was installing metal duct work using a double insulated drill connected to a drop light cord. Power was supplied through two extension cords from a nearby residence. The individual's wet clothing/body contacted bare exposed conductors on one of the cords causing an electrocution. No GFCI's were used. Additionally, the ground prongs were missing from the 2 cords.

COMMENTS:

1. Although it was suggested above to use double insulated tools, it does not relieve the employer from providing ground fault protection. Extension cords in use between a fixed electrical system (permanent outlet) and a tool can become worn with exposed energized conductors. Therefore, ground fault protection or an AEGCP would be required. See OSHA CLARIFICATION LETTER below.
2. According to OSHA^[10] there were 48 fatalities in the years 1985 to 1989 related to 120 volt electrical systems.
3. Employers have attempted to skirt the requirements of providing ground fault protection by using 30 amp breakers in their 120 volt, single phase systems. This not only defeats the intent of the ground fault provisions it also introduces another set of hazards because the system is no longer rated from the actual over current protection (30 amp breaker) that is in place.

ADDITIONAL DOCUMENTS TO AID IN COMPLIANCE:

[1] Section 404(b); [3]; [4]; [5]

OSHA CLARIFICATION LETTER

Date 11/4/92; Directorate Compliance Programs to Private Company; Synopsis - If all extension cord sets and/or portable tool assemblies are approved and used in such a manner that the entire lengths of all cords which are provided power from either permanent or temporary wiring are provided with GFCI protection then the employer would be in compliance. If any of the cords or tools in a series are not protected by a GFCI, then an AEGCP would be required for all the cords and tools including the ones which are protected by a GFCI.

PHOTOGRAPHS, ILLUSTRATIONS and OTHER DOCUMENTS

RECEPTACLES WHICH ARE IN USE BY EMPLOYEES SHALL HAVE GFCI'S FOR PERSONNEL PROTECTION OR THE ASSURED EQUIPMENT GROUNDING PROGRAM^[31]

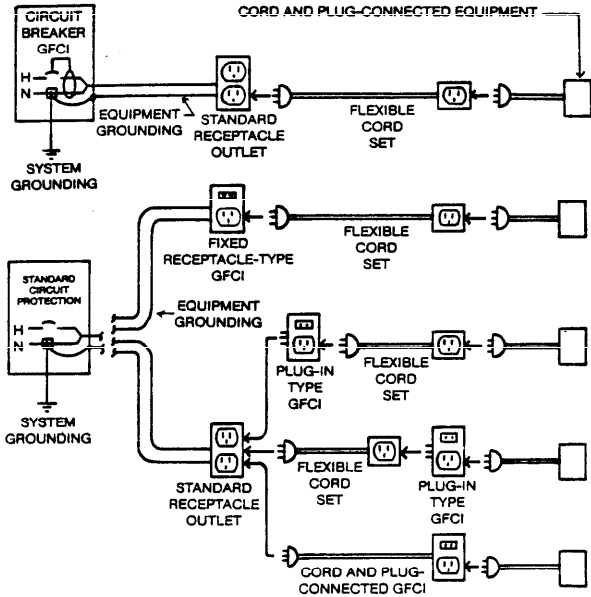

RECEPTACLES WHICH ARE NOT A PART OF THE PERMANENT WIRING CAN BE PROTECTED IN ONE OF SEVERAL WAYS USING GFCI'S.

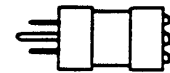
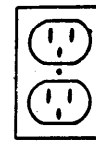

RECEPTACLE TESTER

120 VOLT, SINGLE-PHASE, 15 OR 20 AMPERE FIXED RECEPTACLE OUTLET

TEST FOR CORRECT CONNECTION AND ELECTRICAL CONTINUITY OF THE EQUIPMENT GROUNDING CONDUCTOR

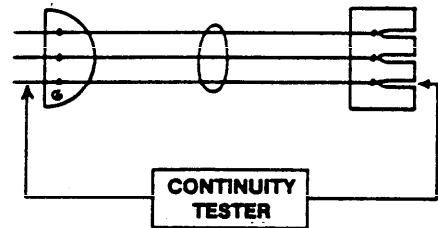

FLEXIBLE CORD SET FOR 120 VOLT 15 OR 20 AMPERE RECEPTACLE

A DOCUMENTED TESTING PROCEDURE MAY BE SUBSTITUTED FOR THE USE OF GFCI'S.

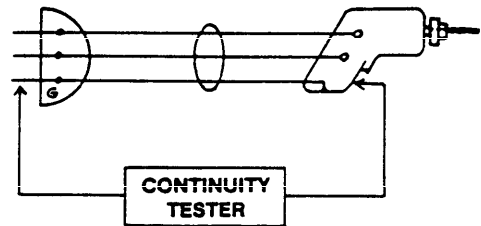

120 VOLT CORD AND PLUG-CONNECTED EQUIPMENT

CONSTRUCTION SITES

<u>RANK IN FREQUENCY CITED</u>	1926.	ELECTRICAL PATH TO GROUND MISSING OR DISCONTINUOUS
#4	404(f)(6)	

RULE: *Grounding Path. The path to ground from circuits, equipment, and enclosures shall be permanent and continuous*

INTENT:

Many times on construction sites due to the frequency and severity of use, electrical equipment that is originally designed and provided an electrical path to ground is not capable of physically transferring “fault” current to ground because he positive physical path (a direct positive connection through the entire system usually terminating at a ground rod or cold water pipe) to ground, sometimes known as the "ground wire" or "equipment ground" is proved to transfer fault current to ground in the event that an exposed part of the piece of equipment were to be energized by the "hot" conductor or wire in the system, i.e. the case of an electric drill might be energized by fault current if the internal windings came in contact with the case or contact is made with an exposed conductor. The "equipment ground" would, in the case of the drill, provide a favorable path of least resistance for the fault current to ground through the conductor. If the “equipment ground” was not continuous the path of least resistance from the drill might be through a persons body.

HAZARDS:

Electrical shock; Probable injuries range from death to minor burns; Fire; Explosion; Electric shock has been the initiator of other Type hazards, i.e. electrical shocks have been the initiating cause of employees falling from elevated work surfaces, WNW shocks have caused employees to lose control of hand held equipment which in turn has struck and injured other employees in the immediate work area, etc.

(AMONG OTHER) SUGGESTED ABATEMENTS:

- Instruct employees to visually inspect all electrical equipment prior to use. Any defects such as frayed cords, missing ground prongs, cracked tool casing, etc. should be corrected by taking the tool out-of-service. Apply a warning tag to the tool and do not allow it to be used until the problem has been corrected.
- Frequently inspect electrical systems to insure the path to ground is continuous. A volt-ohm meter rated for the proper capacity could be used to check for ground in an electrical circuit A receptacle circuit tester can be used to check the continuity of the grounding conductor from a 120 volt receptacle back to ifs origin at the breaker box. This type tester depending on manufacturer usually has the ability to check for wiring configurations including correct wiring, reversed polarity, open neutral, open hot, etc. Additionally, it is relatively inexpensive- usually less than \$20 dollars and can be easily carried in a pants pocket. A pocket pen light continuity checker is an inexpensive piece of equipment that can be used to check the "equipment bonding" conductor of cord and plug connected equipment, i.e. drills, saws, sanders, etc.
- Use double insulated tools. Double insulated tools protect the user from fault currents which might energize the case of the tool or equipment. If electrical equipment is double insulated it must be distinctively marked.

SELECTED CASE HISTORIES

A fan connected to a 120-volt electrical system via an extension cord provided ventilation for an employee performing a chipping operation from an aluminum. stepladder. The insulation on the extension cord was cut through and exposed bare energized conductors which made contact with the ladder. The ground wire was not attached on the male end of the cord's plug. When the energized conductor made contact with the ladder, the path to ground included the employee's body resulting in death.

COMMENTS

1. A large majority (estimated from many compliance staff sources) of the citations under this standard are issued because ground prongs are missing from cord and plug connected equipment or extension cords.
2. Sometimes ground prongs are intentionally removed from tools and extension cords because, “it makes them easier and quicker to plug into and remove.” Statements such as these heard from employees clearly indicate that they do not understand the importance of the of the components of the equipment grounding system.
3. For five years, citations were issued to the contractor who employed the deceased employee in 93 fatality/catastrophe investigations that OSHA conducted, where the absence of a required equipment grounding conductor or lack of continuity of the conductor were listed as a factor.

ADDITIONAL DOCUMENTS TO AID IN COMPLIANCE

[1] Section 404(f); [2] pg. 5; [3] pgs. 35-58; [4]; [5] Art. 250

PHOTOGRAPHS, ILLUSTRATIONS and OTHER DOCUMENTS

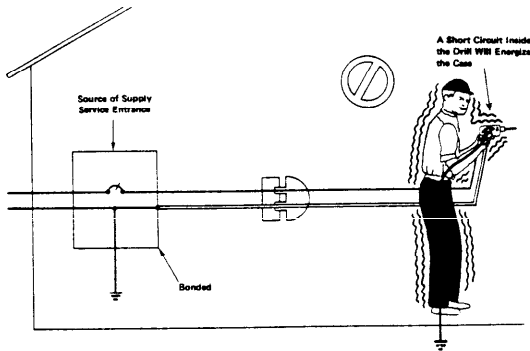

IF A FAULT OCCURS, THE CURRENT WILL FOLLOW THE PATH OF LEAST RESISTANCE TO GROUND. IF THE WORKER PROVIDES A PATH TO GROUND AS SHOWN, SOME PORTION OF THE CURRENT WILL FLOW AWAY FROM THE GROUNDED WHITE CONDUCTOR (NEUTRAL) AND RETURN TO THE GROUND THROUGH THE WORKER. THE SEVERITY OF THE SHOCK RECEIVED WILL DEPEND ON THE AMOUNT OF CURRENT THAT FLOWS THROUGH THE WORKER.

CORD AND PLUG CONNECTED EQUIPMENT WITHOUT A GROUNDING CONNECTOR.

VIOLATION IN-COMPLIANCE

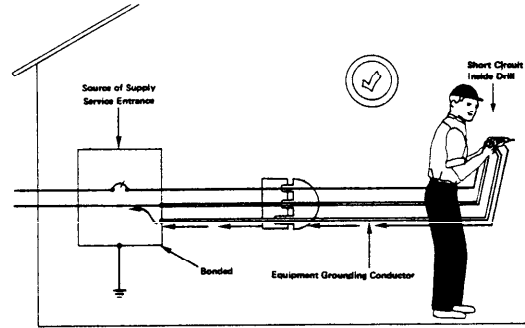

DANGEROUS FAULT CURRENT NOW IS REDIRECTED ALONG THE EQUIPMENT GROUNDING CONDUCTOR BACK TO THE SOURCE OF ELECTRICAL SUPPLY TO OPERATE OVERCURRENT DEVICE.

CORD AND PLUG CONNECTED EQUIPMENT WITH A GROUNDING CONNECTOR.

VIOLATION IN-COMPLIANCE

VIOLATION IN-COMPLIANCE

Equipment grounding conductor, i.e. ground prong, missing (arrow).

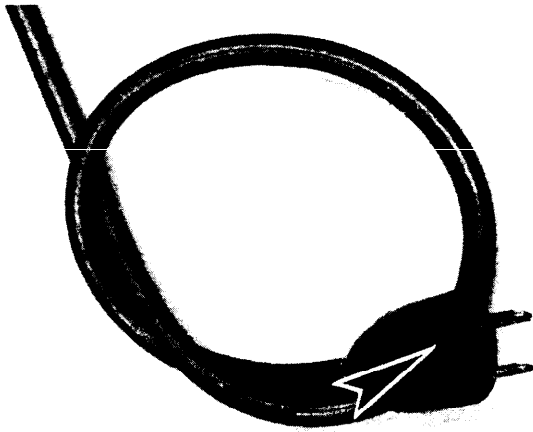

VIOLATION IN-COMPLIANCE

Ground prong (arrow) in-place and conductor is continuous.

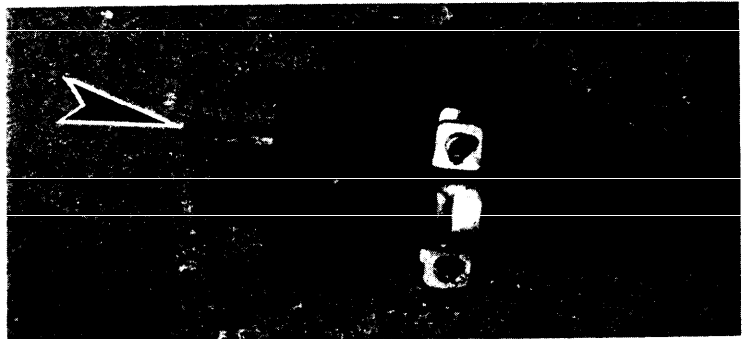

VIOLATION IN-COMPLIANCE

2 conductors (arrow) from non-metallic (NM) sheath cable rigged to multi-receptacle extension cord. No grounding provided. NOTE: Other violations include using NM cable in a manner not prescribed and strain relief was not provided for the other attachment plug shown (see tape at base of plug).

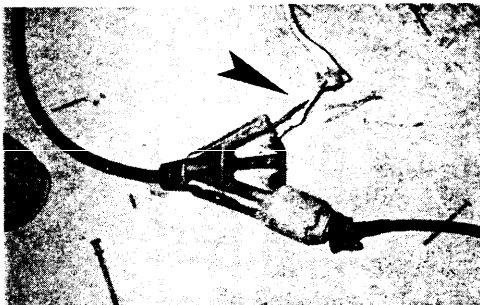

<u>RANK IN FREQUENCY CITED</u>	1926.	
#5	652(a)(1)	PROTECTIVE SYSTEMS FOR TRENCHING/EXCAVATING

RULE: *Each employee in an excavation shall be protected from cave-fns by an adequate protective system designed in accordance with paragraph (b) or (c) of this section..*

INTENT:

Excavation accidents often result in serious injury or death. California reports a ratio of lost-time accidents to fatalities ^[14] for cave-ins aqua to 14:1. In contrast that same ratio for all types industry in California a 250:1. From 1985-1989 OSHA investigated 239 excavation fatalities ^[10]. This rule is basically a general rule and it's intent is to state that the employer will utilize some means of protection when employees are working in an excavation. This standard requires employers to protect employees from cave-ins. Later paragraphs, Paragraph (b) "Design of Sloping and Benching Systems" and Paragraph (c) "Design of Support System, Shield Systems and Other Protective Systems give specific alternatives and corresponding appendices to help the employer comply with the rule (NOTE: Appendices A - F provide valuable information for complying with the standard). The rule does not cover excavations in stable rock and excavations less the 5 feet deep - ONLY when the competent person evaluates the excavation and states there is no potential for cave-ins.

HAZARDS:

A cave-in is the greatest risk associated with excavation, Fatalities can be expected if a cave-in occurs. Other type hazards which are similar to confined space situations should be expected including asphyxiation due to lack of O₂, inhalation of toxic materials, fire, drowning, etc. Moving machinery near the edge of the excavation can cause a surcharge (overloading) of the excavation wall that can cause collapse. Plus, the same machinery and vehicular traffic can strike employees. Many accidence occur when workers contact or sever underground utility lines.

(AMONG OTHER) SUGGESTED ABATEMENTS:

- o Pre job planning is vitally important to this operation. The soil must be evaluated so the employer can select an appropriate protective system. Utilities must be contacted so they can identify their underground lines, traffic control may be an issue, an attempt to identify previous site history must be made, in. was the excavation previously backfilled?, etc.
- o Construct all protective systems in accordance with the standard.
- o Inspect the site daily at the start of each shift, following a rainstorm or after any other hazard increasing event.
- o Keep excavations open *the minimum* amount of time needed to complete operations.

SELECFED CASE HISTORIES:

- o Two employees were installing 6' PVC pipe in a 40 long x 9t x 2t wide trench. No means of protection was provided in the vertical wall trench. A cave-in occurred fatally injuring one employee and causing serious facial injuries to the second employee.
- o An inadequately protected trench wall collapsed killing one employee who had just gotten into the trench to check grade for installation of an *sn* sewer line. The trench was = 201-25, deep and had been benched ≈ one bucket width (40 on each side. At the time of collapse the backhoe was extracting soil from the trench.
- o Four employees were in an excavation 9, wide x 3V long x 71 deep were boring a hole under a road. Eight foot steel plates used as shoring were placed against the side walls of the excavation at about 30 degree angles. No horizontal bracing was used. One of the plates tipped over crushing an employee.

COMMENTS:

1. Of all the excavation standards, this one is cited the most often because it is the appropriate standard to cite when no protection at all is provided. Unfortunately, many employers engaged in this activity, still provide no protection for their employees.
2. This standard is written in a unique manner -"Each employee..", which gives OSHA, the option to cite this particular standard for each exposed employee.
3. This standard was cited in 47 fatality/catastrophe inspections conducted by the Agency from March 1990 to January 1992.

ADDITIONAL DOCUMENTS TO AID IN COMPLIANCE:

[14], [20]

PHOTOGRAPHS, ILLUSTRATIONS and OTHER DOCUMENTS

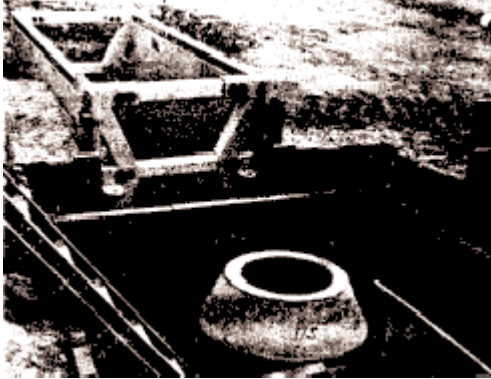

VIOLATION IN-COMPLIANCE

Properly constructed timber shoring and trench box (left)

NOTE: The plywood (bottom right) is not a structural member of the shoring system. It is to be used only to prevent the soil in the sidewalls from raveling.



VIOLATION IN-COMPLIANCE

Employees in vertical wall trench with no sidewall protection (above).



VIOLATION IN-COMPLIANCE

Improper shoring including bracing is not secured (above)

VIOLATION IN-COMPLIANCE

Employees is exposed (arrow) between concrete manhole and unprotected sidewall of excavation (right).



<u>RANK IN FREQUENCY CITED</u>	1926.	GUARDRAIL SPECIFICATIONS FOR TUBULAR WELDED FRAME SCAFFOLDS
#6	451(d)(10)	

RULE: *Guardrails made of lumber, not less than 2 x 4 inches (or other material providing equivalent protection), and approximately 42 inches high, with a midrail of 1 x 6 inch lumber (or other material providing equivalent protection), and toeboards, shall be installed at all open sides and ends on all scaffolds more than 10 feet above the ground or floor. Toeboards shall be a minimum of 4 inches in height. Wire mesh shall be installed in accordance with paragraph (a)(6) of this section.*

INTENT:

OSHA investigated 214 fatalities from 1985-1989 ^[10] related to falls from scaffolds. The intent of this standard is to provide specifications for a fall prevention system, i.e. standard guardrails and toeboards, on tubular welded frame scaffolds. Because this is a specification standard it only applies to tubular welded frame type scaffolds. Note: This standard requires both standard guardrails and toeboards at a height of 10'. The general scaffold requirement 1926.451(a)(4) which requires guardrails between 41-10, when the minimum horizontal dimension of the scaffold is < 45', does not include tubular welded frame scaffolds, see **OSHA CLARIFICATION LETTER** below. Other guardrail materials which would provide equivalent protection are listed in TABLE 5.2-1. When persons must work or pass under a tubular welded scaffold, wire mesh construction is required. This includes a minimum No. 18 gauge US. Standard wire ½-inch mesh or equivalent extending along entire opening from toeboard to top rail. If persons are not required to work or pass under the scaffold only a toeboard is necessary (see TABLE 5.2-2 for acceptable toeboard specifications).

HAZARDS:

- Fall from elevation. Probable injuries range from death to severe sprains/strains.
- Struck by falling objects from scaffold platforms with insufficient material containment systems, i.e. wire mesh screen or toeboards. Probable injuries could include death or lost-time injuries due to head concussion, broken bones in the upper body areas, etc.

(AMONG OTHER) SUGGESTED ABATEMENTS:

- Whenever employees must work any elevated location, ask: 1) Are they protected from a fall? and 2) What measures must be taken to protect the employee at the elevated work location?
- Fall prevention systems such as standard guardrail systems provide a more positive means of protection than fall protection systems such as the use of a bodybelt/harness-lanyard-lifeline combination.

SELECTED CASE HISTORIES:

- An employee preparing masonry facia for removal from a building fell from the third level of a tubular welded frame scaffold. No guarding system was provided for the scaffold. Further, the platform was coated with ice creating a slippery condition.
- A contract employee was taking measurements inside a reactor vessel from an unguarded tubular welded frame scaffold when he either lost balance or stepped backwards and fell ≈ 14 ½', sustaining fatal injuries.

COMMENTS:

1. Many scaffolding guardrail violations are issued because no railings were provided on the ends of the scaffolds. Remember, a fall prevention system is not complete until the scaffolding is completely enclosed. Additionally, this is a specification standard, therefore, it is more easily identified and substantiated as a violation when the guarding is not provided.
2. Scaffold cross-bracing (X braces) are not acceptable alternatives for guardrails.
3. Many times scaffold guardrail are provided for tubular welded frame scaffolds where only one or two 10" planks are provided for a 60" wide scaffold end frame. This is ineffective because there is a potential for an opening 40"-50" between the edge of the "platform" and the guardrail (if in-place). Instead of falling over the edge of the scaffold, employees are exposed to falling through the scaffold.

ADDITIONAL DOCUMENTS TO AID IN COMPLIANCE:

[1] Section 451(a) & (d), [17]

OSHA DIRECTIVE #100-58 (STD 3-10.3)

Date 10/30/78-Synopsis - Wire, chains, synthetic and fiber apes may be used as guardrails as per equivalent requirements of 1926.451 (a) (5) provided it meets the following guidelines: 1) it is secured to each support and taut at all times; 2) it is free of sharp edges; and 3) it has a maximum deflection of 3" in any direction when a 200 lb. load is applied.

Note: No size requirements of the ropes are listed in directive.

OSHA CLARIFICATION LETTER

Date 3/11/83; From Acting Regional Administrator Region III to Area Director; Synopsis – 1926.451(a)(4) – General Scaffold Requirements, guarding in particular – If a specific type scaffold is covered by a standard such as tubular welded frame guarding doesn't need to be provided as per 451(a)(4) from the 4' – 10' level unless adjacent to dangerous equipment. NOTE: This position was reaffirmed in a letter dated August 7, 1992 from the Acting Assistant Secretary to an individual company.

PHOTOGRAPHS, ILLUSTRATIONS and OTHER DOCUMENTS



End frame not guarded.
NOTE: The hole between the scaffold planks is large enough to fall through (left).

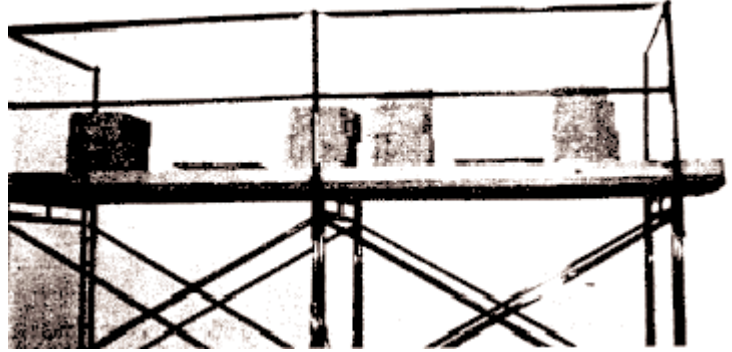

VIOLATION IN-COMPLIANCE

A properly erected guardrail system with top rail, mid rail and toeboard.

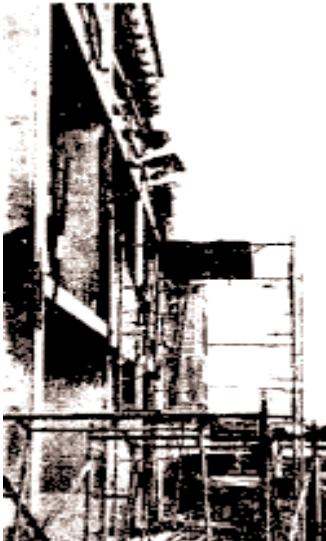

121/2 ft. tall scaffold (left) with no fall protection provided.

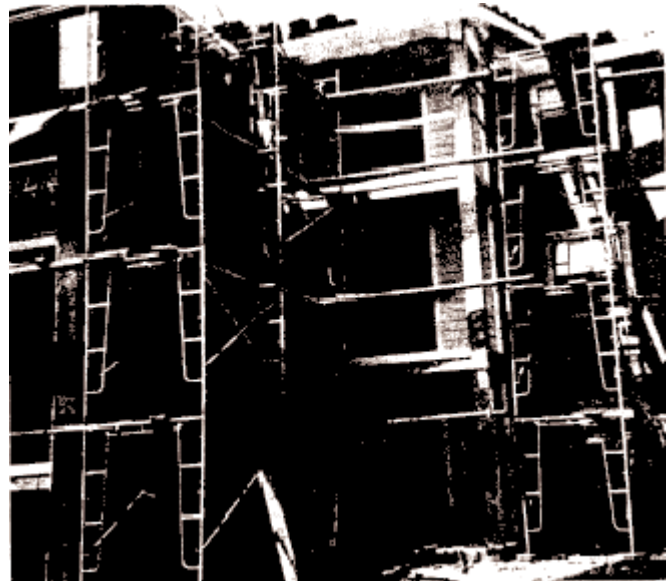

VIOLATION IN-COMPLIANCE
(above left, left, immediately above)

4 buck high scaffold (above) with no guardrail system any of the 4 working heights.
NOTE: The incomplete platforms and deficient erection of the structural members.

<u>RANK IN FREQUENCY CITED</u>	1926.	
#7	28(a)	APPROPRIATE PPE USED FOR SPECIFIC OPERATION

RULE: *The employer is responsible for requiring the wearing of appropriate personal protective equipment in all operations where there is an exposure to hazardous conditions or where this part indicates the need for using such equipment to reduce the hazards to the employees.*

INTENT:

This rule gives the employer responsibility for insuring that employees wear appropriate PPE to reduce the exposure to hazardous conditions such as falling objects, toxic atmospheres, noise exposure, etc.. **PPE is not only a right for the employee - it is a responsibility for the employer.** This standard is part of Subpart C - General Safety and Health Provisions. Specific PPE and life saving equipment requirements are found in Subpart E, including: head protection; hearing protection; eye and face protection; respiratory protection; safety belts, lifelines, and lanyards; and safety nets. The Subpart E requirements are usually more specific than the Subpart C requirement. 1926.28(a), therefore, the standards in Subpart E are utilized more often than 1926.28(a). For example 1926.100(a) is #2 on the 100 **Most Cited Physical LIST**, conversely 1926.28(a) is #7. The Subpart E standards give specifications/guidance for selecting, use and maintenance of appropriate types and levels of PPE depending on the types of hazards employees are exposed.

HAZARDS:

Hazards can range from falling objects or bodies to inhalation of toxic materials. The injuries related to this standard also vary widely, including instant death from the inhalation of a highly toxic substance to a minor burn.

(AMONG OTHER) SUGGESTED ABATEMENTS:

- Evaluate the operations, define the hazards. When it **IS** not feasible to design out all hazards, it may be necessary for employees to wear PPE.
- Discipline workers who fail to wear PPE. Because PPE can be uncomfortable, cumbersome, hot etc., employees sometimes don't wear it even though they know they may be risking injury. When an employee has been given repeated warnings about not wearing PPE, but still does not wear it, it may be prudent for the employer to impose appropriate penalties, leading to release if the employee persistently chooses not to follow company safety rules.
- Another system that has shown to work is to require employees, as a condition of employment, wear PPE at all needed times.

SELECTED CASE HISTORIES:

An employee was working with a crew setting a metal elbow duct for a bag house when he fell ≈ 50' to his death. The victim was wearing a safety belt with lanyard; however, the lanyard was not attached to any tie-off support.

COMMENTS:

1. Several United States Courts of Appeals have vacated citations relying on this standard as a requirement for fall protection. However, as can be seen by the numerous violations related to the standard the Agency was still enforcing it in 1991. In response to the courts, OSHA developed guidelines to use 1926.28(a) & 1926.105 for fall protection. Those guidelines were set forth in STD 3-3.1. See below for a synopsis of that STD. However, STD 3-3.1 has been canceled and is no longer in effect, See **OSHA NOTICE CPL 2** below.
2. This standard was cited in 257 fatal/catastrophe inspections in 5 years by the Agency.

ADDITIONAL DOCUMENTS TO AID IN COMPLIANCE:

[1] Sections 1926. 100, 101, 102, 103, 104, 105 & 106; [7]*, [8]*, [9], [12], [13], [15]*, [16]; [25]
 *- Referenced in 29 CFR 1926- Construction Standards

OSHA. INSTRUCTION STD 3-3.1

Date 7/18/83; Synopsis - Clarifies using 1926.28(a) & 1926.105(a) as fall protection requirements. Gives guidance as to how to apply the standards. General guidance is to provide safety belts-lanyards at heights > 10' and < 25'. Above 25' provide safety new or other means of adequate fall protection. Other specific guidance is provided. Note - this STD has been canceled. OSHA Notice CPL 2 is currently in effect, see next page.

PHOTOGRAPHS, ILLUSTRATIONS and OTHER DOCUMENTS

OSHA Notice CPL 2

October 5, 1992

Office of Construction and
Maritime Compliance Assistance

Subject: Cancellation of OSHA Instruction STD 3-3.1

- A. Purpose notice cancels an OSHA Instruction based on court decisions that make the guidance given in the instruction inaccurate.
- B. Scope. This notice applies OSHA-wide.
- C. Cancellation. OSHA Instruction STD 3-3.1, July 18, 1983, "Fall Protection in Construction: 29 CFR 1926.28(a) and 29 CFR 1926.105(a)," is canceled.
- D. Expiration Date. This notice expires on October 30, 1992.
- E. Action. Users of the OSHA Directives System shall remove from their files and discard OSHA Instruction STD 3-3.1.
- F. Background. The Review Commission has held in the LE Meyers Company case, OSHRC Docket No. 82-1137, that the December 1972 revision to 1926.28(a) was invalid on the grounds that the change from "and" to "or" was substantive change that could not be accomplished without notice and comment rulemaking. This decision holds that 29 CFR 1926.28(a) may not be cited unless there is exposure to a hazardous condition and the need for personal protective equipment is indicated elsewhere in the Part 1926/1910 Construction Industry Safety and Health Standards.

In view of this decision, use of 1926.28(a) is superfluous. If a hazard is addressed by another standard, such as 1926.105 for a fall greater than 25 feet, the other standard should be cited. Recognized failing hazards not covered by an existing standard shall be cited in appropriate cases under the general duty clause as indicated in Chapter N of the Field Operations Manual.

Directorate of Compliance Programs

NOTE: Even though the use of this standard has been curtailed. It is strongly recommended by OSHA that the employer evaluate all operations employees are involved with at a worksite to determine what hazards might exist and the appropriate measures including PPE which can be utilized to eliminate or control the hazard. All other PPE requirements specifically addressed by OSHA as well as industry recognized requirements for wearing PPE are still being enforced by the Agency by utilizing specific standards or the General Duty Clause - 5(a)(1).

<u>RANK IN FREQUENCY CITED</u>	1926.	
#8	1052(c)(1)	STAIR RAILS REQUIRED AT 30" CHANGE OF ELEVATION OR 4 RISERS

RULE: *Stairways having four or more risers or rising more than 30 inches (76 cm), whichever is less, shall be equipped with at least one handrail and one stairrail system along each unprotected side or edge. However, when the top edge of a stairrail system also serves as a handrail, paragraph (c)(7).*

INTENT:

OSHA estimates that 4 fatalities, 5400 impact injuries and 1900 sprain/strain injuries occur annually on stairways^[18]. About 65% of those injured required medical treatment. The intent of this standard is to require the use of stairrail systems and handrails when a set of stags is > 30" in height or it has ≥ 4 risers and an unprotected edge. Walls or stairrail systems (vertical barrier consisting of a handrail, mid rails and constructed similarly to guardrail systems [See TABLE 5.2-1]) can guard an unprotected edge. Note: the top edge of a stairrail system can serve as a handrail. The top edge of the stairrail system which is used as a handrail shall be < 37"-36" > from the surface of the tread measured in line with the face of the riser.

HAZARDS:

Fall from elevation; can be fatal. Most likely injuries range from broken bones to sprains/strains.

(AMONG OTHER) SUGGESTED ABATEMENTS:

- Identify all access points where there is a break in elevation of ≥ 19". Are all these access points provided a stairway/ladder? Does every access/egress area have a stairway/ladder or some other equivalent safe means of access/egress? Are the stairways constructed/maintained properly?

SELECTED CASE HISTORIES:

The OSHA IMIS system included no fatalities directly caused by failing to adhere to this standard (since January 1991 when standard came into effect).

1. This is another of the more common situations found on construction sites which are covered by specification standards that are easily identified and substantiated as a violation. This is probably a reason it is quite high on the list.
2. This standard became effective in January 1991. The old previous standard (1926.500(e)(1)(iii)) ranked #80 on the 1991 List of the Most Frequently Cited Physical Hazards. The two standards taken together would rank #7 on the 100 **Most Cited Physical** List and #13 on the 100 **Most Cited** List.
3. One of the most common stairway violations found on a construction site is the complete absence of stairs or no stairrails for the risers leading into the equipment trailer [Conversations with CSHO's].

ADDITIONAL DOCUMENTS TO AID IN COMPLIANCE:

[18], [19]

PHOTOGRAPHS, ILLUSTRATIONS and OTHER DOCUMENTS

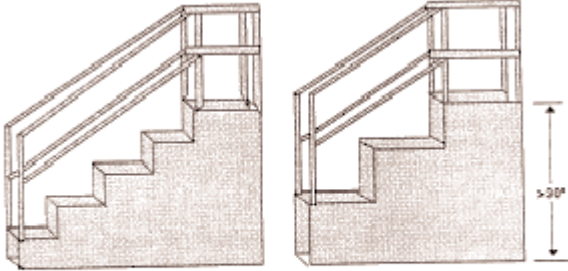

STAIRRAIL SYSTEM REQUIRED FOR 4 OR MORE RISERS*

CHANGE IN ELEVATION GREATER THAN 30" REQUIRES A STAIRRAIL*

* FOR ALL UNPROTECTED EDGES.
NOTE: A WALL OR EQUIVALENT BARRIER CAN BE UTILIZED IN LIEU OF STAIRRAILS.

VIOLATION IN-COMPLIANCE

Stairrail systems which meet OSHA erection specifications.



VIOLATION
 IN-COMPLIANCE

No guarding provided for a 6 riser stairway.

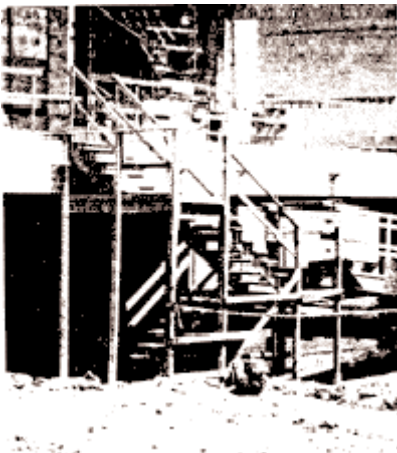

VIOLATION IN-COMPLIANCE

Properly erected stairway and stairrail system.

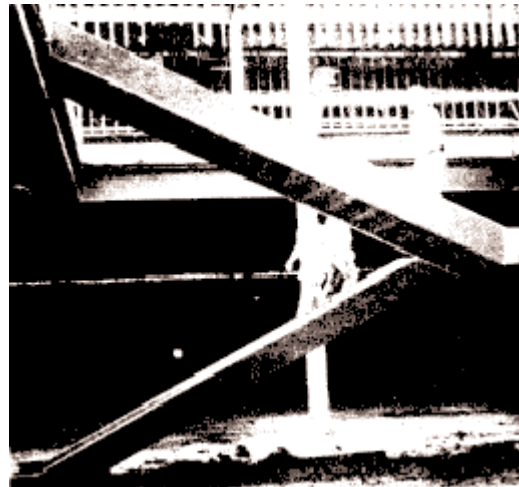

VIOLATION IN-COMPLIANCE

Guarding not provided for the unprotected edge

<u>RANK IN FREQUENCY CITED</u>	1926.	APPROVED CONTAINERS OR TANKS FOR STORING OR HANDLING FLAMMABLE OR COMBUSTIBLE LIQUIDS
#9	152(a)(1)	

RULE: *Only approved containers and portable tanks shall be used for storage and handling of flammable and combustible liquids. Approved metal safety cans shall be used for the handling and use of flammable liquids in quantities greater than one gallon, except that this shall not apply to those flammable liquid materials viscid (extremely hard to pour), which may be used and handled in original shipping containers. For quantities of one gallon or less, only the original container or approved metal safety cans shall be used for storage, use, and handling of flammable liquids.*

INTENT:

The intent is to provide acceptable containers (Approved safety cans) for the handling, use and storage of flammable and combustible liquids. Because these materials can ignite and cause fires or explosions this standard requires an "Approved Metal Safety Can". The approved safety can may have a maximum five gallon capacity and must include a spring closing lid and spout a flame arrestor, and a design to relieve internal pressure in a safe manner when exposed to fire. "Approved" means equipment that has been listed or approved by a nationally recognized testing laboratory. The standard does not apply to highly viscid materials in their original shipping containers nor to any flammable or combustible liquids in quantities 1 gallon in their original containers or in approved metal safety cans. OSHA now recognizes approved plastic containers, see discussions below.

HAZARDS:

Fire and/or explosion; ault likely injuries range from fatalities to 1st degree burns.

(AMONG OTHER) SUGGESTED ABATEMENTS:

- When handling, storing or using flammable and combustible materials, follow all fire prevention rules such as no smoking. Bond and ground all containers when transferring contents to eliminate the possibility of static charge and a potential ignition source.
- Survey your worksite to determine if flammable and combustibles are being used. Then determine if they are being used, transferred, and stored in a safe manner as prescribed by OSHA and NFPA.

SELECTED CASE HISTORIES:

There were no fatality/catastrophes listed in BUS for the past five years directly tied to violations of this standard. However, the inadequate use, transfer and storage of these materials has caused many serious burns.

COMMENTS:

1. Frequently gasoline I brought on site in a 2½ or 5-gallon unapproved can that was purchased at a local hardware store. Because this is a specification standard the violation is very easy to identify and substantiate (conversations with OSHA CSHOs).
2. Plastic containers can lx used as an "approved" container 11 they have been "approved" by a nationally recognized testing laboratory. See below.

ADDITIONAL DOCUMENTS TO AID IN COMPLIANCE:

[1] Subpart F

OSHA COMPLIANCE MEMORANDUM

Dates 7/19/89; From Directorate of Compliance Programs to Regional Administrator VI; Synopsis- Clarification stating that the term "approved" applies to the use of plastic containers in lieu of metal safety cans when they are approved as containers for flammable liquids over one gallon by Underwriters Laboratories (UL) or Factory Mutual (FM) (or other nationally recognized testing laboratory).

OSHA ISTRUCTION STD 3-4.1A

Date 9/16/80; From OSHA Compliance Programming; Synopses- 1926.155(l) requires a flash arrestor screen for an approved metal safety can. FM requires flame arrestor screens in their approvals of safety cans; however, UL does not require the arrestor screens in their safety can approval. NFPA 30 recognizes approval of both FM or UL. Therefore, any citation issued under this standard for lack of the flame arrestor screen only is de minimis.



VIOLATION IN-COMPLIANCE

An approved safety can. The arrows show the self closing cover and flame arrester

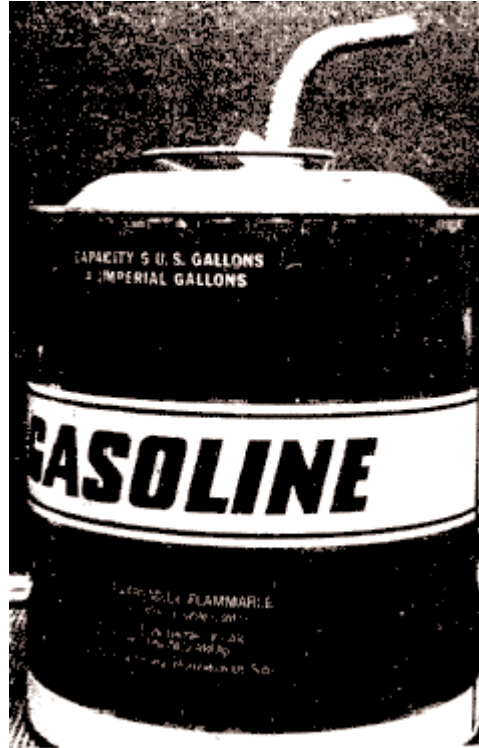

VIOLATION IN-COMPLIANCE

A common can on the market for gasoline. However, the can is not approved because it does not include a self-closing top.



VIOLATION IN-COMPLIANCE

2 plastic cans which do not meet the criteria for self-closing tops.

<p><u>RANK IN FREQUENCY CITED</u></p> <p>#10</p>	<p>1926.</p> <p>25(a)</p>	<p>GENERAL HOUSEKEEPING</p>
--	---	------------------------------------

RULE: *During the course of construction, alteration, or repairs, form and scrap lumber with protruding nails, and all other debris, shall be kept cleared from work areas, passageways, and stairs, in and around buildings or other structures.*

INTENT:

Since construction sites are dynamic by nature, the work areas often times become cluttered and disorderly creating a hazard. The array of construction debris is almost endless, including wood from old forms, broken pallets, boards with protruding nails and material shipping container to name just a few. At any given time it would not be unexpected to find any area of a construction site with a housekeeping problem. Housekeeping must be on-going as the job progresses.

HAZARDS:

Poor housekeeping can lead to the increased risk of trips, slips and falls. Resulting injuries range from fractures to sprains/strains. Associated hazards include nails in boards responsible for skin punctures resulting in lockjaw. If combustibles are not controlled at the site fires may occur.

(AMONG OTHER) SUGGESTED ABATEMENTS:

- Encourage the first line managers to make a concentrated effort to focus on housekeeping.
- On larger job sites, give laborers specific duties related to housekeeping only.
- On smaller sites, set up a system designating certain employees on an hourly basis to care for housekeeping chores.

SELECTED CASE HISTORIES:

IMIS did not contain any fatality/catastrophe inspections over the past five years, where violations of this standard were a direct/indirect cause(s) of an accident.

COMMENTS:

1. Although identifying a housekeeping violation is a subjective call (no real specific criteria which delineate what an actual housekeeping hazard is) these violations are rarely challenged when the CSHO has a photograph of the particular situation (Conversations with OSHA Area Directors).
2. This standard was cited in 33 OSHA fatality/catastrophe inspections in five years.

ADDITIONAL DOCUMENTS TO AID IN COMPLIANCE:

[1] Section 25 (b) & (c)

PHOTOGRAPHS, ILLUSTRATIONS and OTHER DOCUMENTS

VIOLATION IN-COMPLIANCE

All six worksites below are examples of poor housekeeping.



<u>RANK IN FREQUENCY CITED</u>	1926.	DAILY INSPECTION OF PHYSICAL COMPONENTS OF TRENCH AND PROTECTION SYSTEM
#11	651(k)(1)	

RULE: *Daily Inspections of excavations, the adjacent areas, and protective systems shall be made by a competent person for evidence of a situation that could result in possible cave-ins, indications of failure of protective systems, hazardous atmospheres, or other hazardous conditions. An inspection shall be conducted by the competent person prior to the start of work and as needed throughout the shift. Inspections shall also be made after every rainstorm or other hazard increasing occurrence. These inspections are only required when employee exposure can be reasonably anticipated.*

INTENT:

This rule gives criteria for employees to use in conducting inspections of excavations to identify signs warning of potential cave-in, failure of a protective system, hazardous atmosphere or other hazards. The criteria include the frequency of inspections (daily prior to each shift, throughout shift as needed, after rainstorms or other hazard-increasing occurrence) and the locations of the inspections (excavations, adjacent areas and protective systems). The competent person is responsible for conducting these inspections. The competent person must have specific training in, and be knowledgeable about soil analysis, the use of protective systems and the requirements of the standard. An important provision of the competent person requirement is that he/she must have real authorization to take prompt corrective measures to eliminate hazards.

HAZARDS:

Cave-ins are the most frequent and most dangerous hazard associated with these excavations. Fatalities can be expected if a cave-in occurs. Other type hazards similar to those associated with confined spaces should be expected including asphyxiation due to lack of O₂ inhalation of toxic materials, fire, drowning, etc. Moving machinery near the edge of the excavation can cause a surcharge (overloading) with resulting stress cracks at/near the edge of the excavation wall which can cause collapse. Many accidents occur when employees contact or sever underground utility lines.

(AMONG OTHER) SUGGESTED ABATEMENTS:

- Use the GUIDE FOR THE DAILY INSPECTION OF TRENCHES/EXCAVATIONS on the next page to assist in identifying the warning signs of excavation failure and specific items to evaluate for different trench/excavation protection systems.
- Keep excavations open the minimum amount of time needed.
- RECOMMENDATION ONLY: Prior to giving authorization as competent person conduct a rigorous testing program to assure that his/her knowledge level **IS** functional for the duties and responsibilities of a competent person.

SELECTED CASE HISTORIES:

- An employee was in a 7' 6" deep trench installing forms for concrete footers when the trench caved-in causing fatal injuries. The trench was in loose sandy soil (Type C) and no inspection was conducted prior to the start of the shift/operation.
- An employee in a trench 6' deep x 32' wide was applying a waterproofing primer material containing methyl chloroform and 1,4 dioxane to the foundation of a house. The employee was overcome and latter died of trichloroethane intoxication. Deficiencies rated to the cause of the accident included: 1) no one had tested the atmosphere in the trench; 2) the employees were not provided with respiratory protection; and 3) mechanical ventilation was not used.

COMMENTS:

1. The competent person must be knowledgeable and have the authority to take corrective action.
2. At times the production schedule and the duties of the competent persons conflict, If the competent person's authority, is overridden, overtly or he/she fails to act because he/she believes the company would not support him/her, then in reality there is no true competent person at the excavation site.
3. This standard was cited in 37 fatality inspections conducted by OSHA since March 1990.

ADDITIONAL DOCUMENTS TO AID IN COMPLIANCE:

[14], [20]

OSHA CLARIFICATION LETTER

8/5/92; From Directorate of Compliance Programs to Private Company, Synopsis - A competent person need not present at the site at all times when trenching/excavating operations are being conducted. However, it **IS** the competent person's responsibility to inspect the site to identify hazardous conditions and to take the appropriate corrective action. Therefore, the individual conditions at each site will govern the amount of time a competent person must spend at the site.

GUIDE FOR THE DAILY INSPECTION OF TRENCHES AND EXCAVATIONS^[30]

See next page.

GUIDE FOR THE DAILY INSPECTION OF TRENCHES/EXCAVATIONS^[30]

WARNING SIGNS OF THE FUTURE

- Tension Cracks (In Sidewalls, Slopes and Surface adjacent to Excavation)
- Ground Settlement or Subsidence
- Changes in Wall Slope or Bulge
- Increase in Strut Loads
- Bowing of Struts
- Spalling or Sloughing of Soils
- Excessive Seepage and Piping of Fine Soils
- Softening of Sidewalls
- Boiling of Trench Bottom
- Creaking or Popping Sounds
- Visual Deformation of Bracing System or Trench

SHORING/BRACING CHECKLIST

- Strict Adherence to Plans and Specifications
- Changes in Soil Condition
- Maintenance of Proper Slope Ratio
- Excessive Vibrations
- Location of Spoil Pile
- Equipment Location Relative to Excavation
- Secondary Soil/Rock Structure -
- Presence of Water Seepage and Rainfall
- Location of Trees, Boulders, Structures and Existing Utilities
- Right-of-Way
- Signs of Distress

SLOPING/BENCING CHECKLIST

- Strict Adherence to Plans and Specifications
- Changes in Soil Conditions
- Excessive Vibration
- Location of Spoil Pile
- Equipment Location Relative to Excavation
- Excessive Wear or Damage to Equipment
- Signs of Distress
- Improper Installation Procedures
 - Workers in unbraced trench
 - Improper system being used
 - Improper alignment of members
 - Improper installation of connections
- Location of Existing Utilities and Backfill

TRENCH SHIELD (BOX) CHECKLIST

- Strict Adherence to Plans and Specifications
- Changes in Soil Conditions
- Clearance Between Shield Trench Sidewalls
- Adequate Freeboard at Top of Shield
- Proper Slope Above Shield
- Current Certification of Shield
- Excessive Wear or Damage of Shield
- Improper Use of Shield
 - Workers in unshielded trench
 - Improper shield being used
- Location of Existing Utilities

NOTE: These are only general warnings of failure and recommendations for daily inspections of most trenches and excavations. Every trench/excavation must be inspected by a competent person as per 1926.651(k)(l) for the items listed above and all other hazards which are unique to that site.

<u>RANK IN FREQUENCY CITED</u>	1926.	
#12	451(a)(13)	SAFE ACCESS FOR ALL TYPES OF SCAFFOLDS

RULE: *An access ladder or equivalent safe access shall be provided*

INTENT:

To decrease the risk of a fall, this standard requires a ladder or other equivalent means of access for scaffolds. Too often when ladders are not in place, workers climb the end frames of the scaffold (a common unsafe work practice in the construction industry). This can be hazardous. Depending on the design of the end frame the structural members which are used as ladders rungs can be narrower than the width of an average foot i.e. this case requires the employee to actually stand on the side of his foot on the "rung". The vertical distance between "rungs" also may be excessive (2 ½' – 3'), resulting in the employee reaching for the next "rung". Unless the end frame is designed as a ladder access frame, it must not be used as such. The scaffold manufacturer or dealer can assist the user in determining if a scaffold frame has a built-in ladder. Some of the common frames do not have built-in ladders. Scaffold ladders that attach directly to the frame can be obtained from scaffold dealers. Equivalent safe access to scaffold platforms can include access from a building floor/window directly to the platform, a portable stairway system, etc.

HAZARDS:

Fall from elevation. Probable injuries vary from death to severe sprains/strains.

(AMONG OTHER) SUGGESTED ABATEMENTS:

- Construct all scaffolds and related components (ladder access) as per scaffold manufacturers technical literature.
- Whenever possible, use a window/floor at the elevation of the platform to gain access, thereby, eliminating any hazard associated with climbing.

SELECTED CASE HISTORIES:

While descending the end frame of a scaffold that was not designed to be a built-in ladder, an employee lost his balance, fell 13' to concrete and suffered fatal head injuries.

COMMENTS:

- 1 If the scaffold user has any questions about the scaffold, i.e. construction, use, etc. they should contact the scaffold manufacturer or dealer. Experience has proven that they are fully cooperative and can assist with technical questions.
2. If workers use an attached ladder on the end frame of the scaffold, the scaffold must be constructed to withstand the effects of the overturning force imparted on the scaffold due to the external loading caused by the weight of the person climbing the ladder. A material hoist on the same side as the ladder might increase the overturning force causing collapse of the scaffold. These loading factors must be considered in the design/construction phase.
3. A portable ladder, constructed and used as per Subpart X of 1926 is an acceptable ladder for access to scaffolding.
4. This standard was cited in 35 fatality inspections conducted by OSHA over five years.

ADDITIONAL DOCUMENTS TO AID IN COMPLIANCE:

[1] Section 451; [18] Sections 1051 & 1053-1060 (Subpart X)

OSHA COMPLIANCE LETTER

Date 2/25/83; From Chief, Division of Compliance Prgms., to Individual Company; Synopsis - 1) It's not practical for employer to provide ladder access at all times for employees assembling/disassembling scaffolding; however, other safe access must be provided; 2) end frames designed by a scaffold manufacturer as ladder access are acceptable if they are erected in a continuous line and the maximum spacing between rungs < 16½"; 3) portable wood or metal ladders must comply with Subpart X (formerly Subpart L); 4) fixed ladder standards do not apply to scaffolds; and 5) Subpart X does not apply to built-in scaffold ladders.

OSHA CLARIFICATION LETTER

Date 4/7/87; From Director of Directorate of Field Programs to Regional Administrator; Synopsis - The following relate to designed and manufactured built-in scaffold access ladders: 1) allow a maximum 16½ " rung spacing; 2) rungs may be spaced unevenly where end frames join provided they do not exceed maximum rung spacing; 3) climbing over top guardrail or scaffold board overlay is not a safe practice; and 4) guardrail systems shall be provided with removable rails, chains or gates in accordance with manufacturers' recommendations.

PHOTOGRAPHS, ILLUSTRATIONS and OTHER DOCUMENTS



VIOLATION
 IN-COMPLIANCE

The 2 photos (left) show employees accessing scaffolds by using a hook-on scaffold. NOTE: the inward swinging gate which allows employees to step directly from the ladder on to the platform. Also, the scaffold (far left) has a platform which is not fully planked and creates a hazard.



VIOLATION IN-COMPLIANCE

The scaffold below shows end frames which were designed by the manufacturer to be built-in ladders. NOTE: The chain above the platform guarding opening.

VIOLATION IN-COMPLIANCE

The 2 photos (above & left) show employees using the structural members of end frames as ladders. The scaffold manufacturer did not design these type end frames as built-in ladders. NOTE: The platform violations



<u>RANK IN FREQUENCY CITED</u>	1926.	
#13	404(b)(1)(ii)	GROUND FAULT CIRCUIT INTERRUPTERS (GFCI's)

RULE: *All 120-volt, single-phase, 15-and-20-ampere receptacle outlets on construction sites, which are not a part of the permanent wiring of the building or structure and which are in use by employees, shall have approved ground-fault circuit Interrupters for personnel protection. Receptacles on a two-wire, single-phase portable or vehicle-mounted generator rated not more than 5kw, where the circuit conductors of the generator are Insulated from the generator frame and all other grounded surfaces, need not be protected with ground-fault circuit Interrupters.*

INTENT:

This standard requires the use of electrical hardware that is designed for monitoring ground fault current and is capable of stopping the fault current in the circuit, i.e. through an employee's body. This rule states that all 120 volt 15 & 20 amp receptacles outlets on construction sites will be protected by ground fault circuit interrupters (GFCI's), when not part of the permanent wiring of a structure. Because a receptacle is in effect part of the branch circuit wiring, this rule is effectively identical to 1926.404(b)(1)(1) - GROUND FAULT PROTECTION. For more information related to the operation of GFCI's see #3 **GUIDE** Sheet. This rule exempts portable or vehicle-mounted generators that meet the following: 1) rated < 5kW; 2) system wiring is two wire, single phase; and 3) circuit conductors are insulated from the generator frame and all other grounded surfaces. **NOTE: GFCPS ARE NOT TO BE USED IN LIEU OF EQUIPMENT GROUNDING - GFCPS ARE SUPPLEMENTAL PROTECTION AND MUST ONLY BE CONSIDERED AS A BACKUP TO EQUIPMENT GROUNDING.** GFCI's can be placed anywhere in the circuit and still be effective. They may be put in a panel box as a breaker, at the receptacle or in-line anywhere along an extension cord up to the tool. GFCI's are very important on construction sites because of the likely probability of encountering wet/damp locations that greatly increase the risk of electrical shock.

HAZARDS:

Fatal electrocutions, electrical burns ranging from critical to minor, Fire; Explosion; Electric shock has been initiator of other type hazards, i.e. electrical shocks can cause employees to fall from elevated work surfaces, loose control hand held equipment which in turn can strike other employees in the immediate work area, etc.

(AMONG OTHER) SUGGESTED ABATEMENTS:

- o Frequently trip GFCI's while test tool is operating to insure GFCI is operating correctly.
- o Use double insulated tools. Double insulated tools can protect the user from fault currents which might energize the case of the tool or equipment.
- o GFCI's for 220-volt circuits are available. Note: they are not required by this standard.

SELECTED CASE HISTORIES:

An employee attempted to plug an extension cord into a temporary power spider box. The employee was kneeling on the ground and held the box in his hand. Fault current energized the case of the box and electrocuted the employee. No GFCI's were used.

COMMENTS:

1. Although double insulated tools are recommended, using them does not relieve the employer from providing ground fault protection. Extension cords connecting a fixed electrical system (permanent outlet) and a tool can become worn with exposed energized conductors. Therefore, ground fault protection or an AEGCP would be required. See OSHA CLARIFICATION LETTER below.
2. According to OSHA ^[10] there were 48 fatalities in the years 1985 to 1989 related to 120-volt electrical systems.
3. Employers have attempted to skirt the requirements of providing ground fault protection by using 30 amp breakers in their 120-volt, single-phase systems. This not only defeats the intent of the ground fault provisions, it also introduces new hazards because the system is no longer rated for the actual over current protection (30 amp breaker) that is in place. (Personal experience & conversations with CSHO's).
4. Had all 3 requirements for ground fault protection been combined (1926.404(b)(1)(i) & (ii) & (iii)), they would have been ranked # 1 on the 100 **Most Cited Physical List** and #4 on the 100 **Most Cited LIST**

ADDITIONAL DOCUMENTS TO AID IN COMPLIANCE:

[1] Section 404(b); [3]; [4]; [5]

OSHA CLARIFICATION LETTER

Date 11/4/92; Directorate Compliance Programs to Private Company; Synopsis - If all extension cord sets and/or portable tool assemblies are approved and used in such a manner that the entire lengths of all cords whether provided power from either permanent or temporary wiring, have GFCI protection, then the employer would be in compliance. If any of the cords or tools in a series are not protected by a GFCI, then an AEGCP would be required for all the cords and tools, including the ones already protected by a GFCI.

PHOTOGRAPHS, ILLUSTRATIONS and OTHER DOCUMENTS

The Ground-Fault-Circuit Interrupter ("GFCI") provides an additional precaution

The GFCI is a solid-state, sensitive device which can be applied to open the circuit in case of ground-fault leakage too small to trip the circuit breaker, (but large enough to be dangerous to people).

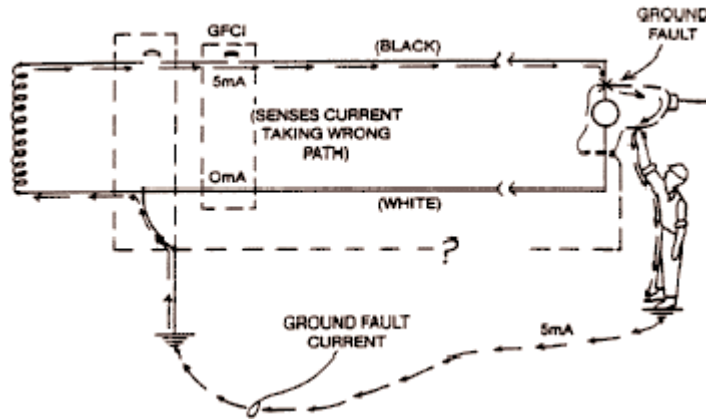

HOW THE GFCI PROTECTS PEOPLE

(BY OPENING THE CIRCUIT WHEN CURRENT FLOWS THRU A GROUND-FAULT PATH.)

Note that the GFCI will open the circuit if 5 mA or more of current returns to the service entrance by any path other than the intended white wire. If the equipment-grounding conductor is properly installed and maintained this will happen as **soon as the faulty tool is plugged in**. If by change this grounding conductor is not intact and low-impedance, the GFCI may not trip out **until a person provides the path**. In this case the person will receive a shock, but the GFCI should trip out so quickly that the shock will not be harmful.

Where are GFCI's required?

OSHA required GFCI's on **construction sites** because of the combined special hazards of two conditions.

- Questionable integrity of the ground-fault path through **temporary wiring**.
- Presence of **wetness** due to working on earth, wet concrete, etc.

VIOLATION **IN-COMPLIANCE**

The use of portable GFCI's (arrow) meets this requirements.



<u>RANK IN FREQUENCY CITED</u>	1926.	
#14	701(b)	GUARDING OF PROTRUDING STEEL REBARS

RULE: Reinforcing steel. All protruding reinforcing steel, onto and into which employees could fall, should be guarded to eliminate the hazard of impalement.

INTENT:

In conversations with construction personnel, they seem to all have an account of a situation where an employee has fallen and Impaled himself on a piece of steel rebar. The accounts are some of the most gruesome stories told related to accidents in the construction industry. This rule requires guarding for the ends of the rebar where the potential impalement could exist. The most common guarding is specially manufactured rebar caps which fit onto the rebar and have rounded surfaces facing upward, or lumber is used and set on top of the rebar. The theory is to dissipate the force of the fall by distributing it over a larger area than the diameter of the rebar, i.e. less force reduces the chance of impalement.

HAZARDS:

Impalement/puncture. Probable injuries can range from death to serious internal injuries.

(AMONG OTHER) SUGGESTED ABATEMENTS:

- Prior to installing rebar at the site, insure enough rebar caps or materials to construct caps will be available.

SELECTED CASE HISTORIES:

- An employee pulling a concrete hose along a form fell 2 stories and hit his head on steel bars which punctured his brain.
- A laborer fell through a roof opening about 8' to a patio foundation that had about 20 half-inch rebar protruding straight up. The laborer was impaled by one of the bars and died.

COMMENTS:

1. This is another example of a specification standard which is easy to identify and substantiate (its either in-place or its not) as a violation. Even though exposed vertical rebar would not be present at many OSHA construction inspections, this situation is being cited very frequently as evident by its #14 ranking on the Most Cited Physical Hazard List. This might be an indicator of industry wide non-compliance.
2. This standard was cited in 12 fatality investigations.

ADDITIONAL DOCUMENTS TO AID IN COMPLIANCE:

[1] Subpart Q, [26]; [27]

PHOTOGRAPHS, ILLUSTRATIONS and OTHER DOCUMENTS

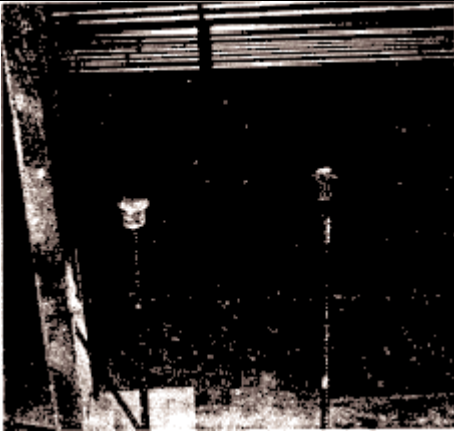

VIOLATION IN-COMPLIANCE

Rebar caps which are acceptable as meeting OSHA requirements.



VIOLATION IN-COMPLIANCE

The arrows show 3 rebars without protective caps which create a hazard.

<u>RANK IN FREQUENCY CITED</u>	1926.	
#15	451(a)(4)	GENERAL REQUIREMENTS FOR GUARDING SCAFFOLDS

RULE: *Guardrails and toeboards shall be installed on all open sides and ends of platforms more than 10 feet above the ground or floor, except needle beam scaffolds (See paragraphs (p) and (w) of this section). Scaffolds 4 feet to 10 feet in height, having a minimum horizontal dimensions in either direction of less than 45 inches, shall have standard guardrails installed on all open sides and ends of the platform.*

INTENT:

This standard specifies when guardrail systems and toeboards are required for all types of scaffolds (General Scaffold Requirements) that are not covered by a specific standard. The requirements for guardrails at specific heights is similar to 1926.451(d)(10). Tubular Welded Frame Scaffolds (See #6 "Most Cited Physical Standards Sheet"), except for scaffolds which are 4' to 10' in height which are not covered by a specific standard. For further explanation see **OSHA CLARIFICATION LETTER** date 8/7/92, below. Guardrail and toeboard construction specifications are contained in 1926.445 (a)(5) & (6). This rule contains an exemption for needle beam scaffolds and floats (suspended scaffolds) and directs compliance with those type scaffolds be in accordance with Paragraphs (p) & (w), respectively. Guardrail systems are not required on these type scaffolds, OSHA requires only safety-belts and lifelines in accordance with 1926.104 for needle beam and float scaffolds.

HAZARDS:

- Fall from elevation. Probable injuries range -from death to severe sprains/strains.
- Struck by falling objects from scaffold platform due to lack of/insufficient material containment system, i.e., wire mesh screen or toeboards. Probable injuries include death, lost-time injuries due to head concussion, broken bones in the upper body, etc.

(AMONG OTHER) SUGGESTED ABATEMENTS:

- Whenever an employee must work at any elevated location ask the questions: 1) Are they protected from a fall? and 2) What measures must be taken to protect the employee at the elevated work location?
- Fall prevention systems such as standard guardrail systems provide more positive means of protection than fall protection systems such as a bodybelt/harness-lanyard-lifeline combination, except when workers are suspended, i.e., from suspended scaffolds, work platforms, etc.
- Construct/maintain all guardrail system according to OSHA requirements.

SELECTED CASE HISTORIES:

An employee was installing overhead boards from a scaffold platform consisting of two 2"x10" boards with no guardrails. He lost his balance and fell 7'6" to the floor sustaining fatal injuries.

COMMENTS:

1. Many scaffolding guardrail violations are issued because no railings were provided on the ends of the scaffolds. The fall prevention system is not complete until it is completely enclosed. Additionally, because the is a specification standard it is more essay identified and substantiated as a violation when guarding is not provided.
2. This standard was cited in 56 fatality investigations over a five year period.

ADDITIONAL DOCUMENTS TO AID IN COMPLIANCE:

[1] Section 451(a) & (d), [17]

OSHA CLARIFICATION LETTER

Date 3/11/83; From Acting Regional Administrator Region III to Area Director; Synopsis - 1926.451(a)(4) - General Scaffold Requirements, guarding in particular - If a specific type scaffold is covered by a individual standard, such as tubular welded frame, Guarding doesn't need to be provided as per 451(a)(4) from the 4' -10' level unless adjacent to dangerous equipment.

OSHA CLARIFICATION LETTER

Date 8/7/92; From - Acting Assistant Secretary to individual company; Synopsis - The interpretation listed above is correct and still in effect. General requirements for scaffolds, 451(a), apply to all scaffolds unless specifically exempted or when the issue is specifically addressed in a specific section for a particular type of scaffold. The requirements for guardrails on scaffolds was specified at a height of 10' (less than 10' in height was omitted) for paragraph .451(b) through .451(y) (standards for particular type scaffolds). Therefore, the .451(a)(4) standard does not apply to any, 451(h) through 451(y), such as proprietary or make shift type scaffolds. Also, clarification of "10' above the ground or floor" was given - it is the falling distance, not the vertical dimension of the scaffold that is the controlling factor.

OSHA CLARIFICATION LETTER

Date 12/88; From Director of Compliance Programs to Regional Administrator; Synopsis - Guardrails not required -for Ladder Jack Scaffolds because they may pose additional hazards and increase risk. The OSHA proposed rule requires the use of a body harness/belt and lanyard for fall protection on these scaffolds.

PHOTOGRAPHS, ILLUSTRATIONS and OTHER DOCUMENTS



VIOLATION IN-COMPLIANCE

An employee using a makeshift single plank scaffold to apply stucco approximately 7'-8' above the ground with no fall protection.



VIOLATION IN-COMPLIANCE

Front and side view (above) of a make shift scaffold 4'-6' above the ground. No fall protection is provided. NOTE: The opening between the scaffold platforms and the unsecured portable ladder.

<u>RANK IN FREQUENCY CITED</u>	1926.	
#16	651(j)(2)	SPOIL PILE PROTECTION

RULE: *Employee shall be protected from excavated or other materials or equipment that could pose a hazard by falling or rolling into excavations. Protection shall be provided by placing and keeping such materials or equipment at least 2 feet (.61 m) from the edge of excavations, or by the use of retaining devices that are sufficient to prevent materials or equipment from falling or rolling into excavations, or by a combination of both if necessary.*

INTENT:
 The intent of this standard is two-fold, by requiring excavated material (spoils) and equipment to be set back 2 feet it accomplishes the following: 1) decreases the risk of spoils or equipment from rolling back into the excavation on top of employees; and 2) reduces superimposed loads on the face of the excavation which possibly could contribute to a cave-in. If the superimposed load of the spoils has been considered in the design of the protection system the spoils may be placed at the face of the excavation if they are retained by a sufficient (strength, i.e. can resist any reasonably anticipated forces applied to it, and/or height) device/operation such as barricading or wire mesh.

HAZARDS:

- Cave-in caused by superimposed load on face of excavation. Probable injury is death.
- Rolling/falling spoils or equipment; Probable injuries could be expected to range from head concussion to bruises. Extreme cases could result in death due to suffocation.

(AMONG OTHER) SUGGESTED ABATEMENTS:

- Conduct a pre-job survey of site to insure the location is large enough to accommodate 2 foot set back for the spoil pile. If not, materials must be obtained to provide an alternate retaining device.
- In some cases contractor may need to haul spoils to a temporary site until excavation is ready to back fill.

SELECTED CASE HISTORIES:
 A spoil pile had been placed on top of a curb which formed the west face of a trench. A backhoe was spotted on top of the spoil pile. The west face of the trench collapsed on two employees who were installing sewer pipe. One employee was killed; the other received back injuries. The trench was 8 feet deep with vertical walls. No other protection was provided. In fact, the superimposed loads of the spoil pile and backhoe may have initiated the collapse.

COMMENTS:

1. Many excavations/trenches dug for utility line are located in narrow right-of-ways. Often spoil piles are placed at the edge with no retaining device. This situation can be avoided with a sound pre-job survey and plan.
2. The fatality rate for trenching/excavation work was 112% higher than the rate for construction in general ^[14].
3. This standard was cited in 37 fatality inspections since it became effective in March 1990.

ADDITIONAL DOCUMENTS TO AID IN COMPLIANCE:
 [1] Section 651(j); [14]; [20]; GUIDE FOR THE DAILY INSPECTION OF TRENCHES AND EXCAVATIONS (See pg.53)

PHOTOGRAPHS, ILLUSTRATIONS and OTHER DOCUMENTS

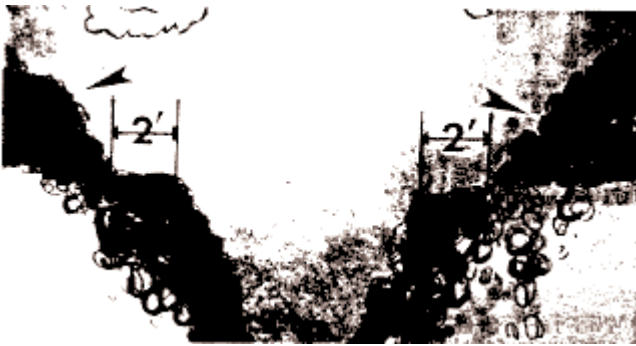

VIOLATION IN-COMPLIANCE

Proper spoil pile set back (above & right).
Arrows show spoil piles.



VIOLATION IN-COMPLIANCE

Two employees along pipe are exposed to the spoil pile
(arrow) which is located on the edge of the trench.
NOTE: Sloping does not meet OSHA requirements.



VIOLATION IN-COMPLIANCE

Employee at end of pipe is exposed to the spoil
pile at the edge of the trench.

<u>RANK IN FREQUENCY CITED</u>	1926.	
#17	350(a)(9)	SECURING OF COMPRESSED GAS CYLINDERS

RULE: Compressed gas cylinders shall be secured in an upright position at all times except, if necessary, for short periods of time while cylinders are actually being hoisted or carried.

INTENT:

This standard specifies the following: 1) gas cylinders must be secured to prevent them from falling against people equipment and other cylinders; if a cylinder strikes a person it can cause an impact type injury, if it strikes nearby equipment the consequences will vary depending on the type of equipment if the first cylinder strikes other unsecured cylinders a domino effect may occur; an unsecured cylinder with its valve protection cap off could fall and strike the valve, rupturing it, causing the compressed gas cylinder to take-off like a rocket; and 2) the cylinders must be stored upright since adverse effects can result if cylinders containing some welding gases are stored/used in a horizontal position. This standard exempts hoisting or carrying cylinders that are only intended to be moved during short periods of time.

HAZARDS:

- Struck by facing or rocketing cylinders. injuries can range from death to contusions.

(AMONG OTHER) SUGGESTED ABATEMENTS:

- Supervisors should note all cylinders in their work area and identify if they are in use or storage. If they are in storage, are they upright, secured and labeled? Is the valve protection cap in place? Are incompatible materials (oxygen and fuel gas) separated properly? If the cylinders are in use, are all appropriate safeguards in place to protect the welder and other personnel in the area?

SELECTED CASE HISTORIES:

OSHA IMIS did not maintain any fatal/catastrophe inspections citing conditions related to this standard as a direct/indirect cause(s) of an accident.

COMMENTS:

1. Welding cylinders placed in welding carts are considered to be secured.
2. Unsecured cylinders on construction sites are common. This is a specification standard which is easily identified and substantiated as a violation as evident of its high ranking on the 100 Most Cited Physical List. Therefore, the contractor must continually audit the site to ensure compliance.
3. This standard was cited in 29 OSHA fatality inspections in 5 years.

ADDITIONAL DOCUMENTS TO AID IN COMPLIANCE:

[1] Section 350; [22]; [23]*; [24]

*- Referenced in 29 CFR 1926 - Construction Standards

OSHA INSTRUCTION STD 3-8.2

Dated 3/11/81 - Synopsis - Clarifies that the standard does not apply to welding gas supply manufacturers or distributors prior to delivery at construction sites. The intent of the standard is for it to apply to welding or cutting operations on construction sites.



CYLINDERS ARE BEST SECURED IN A CART



VIOLATION IN-COMPLIANCE

The cylinders (above & right) are secured properly in an upright position. NOTE: Cylinders are not required to be secured to a cart as shown above. This method is only a recommendation.

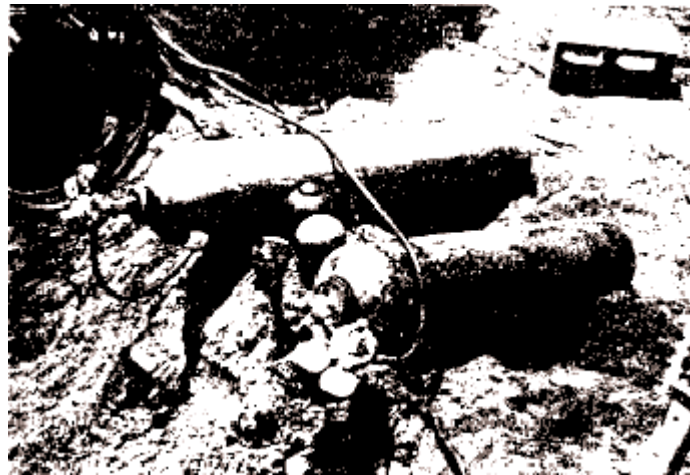

VIOLATION IN-COMPLIANCE

The cylinders are not secured (left) and are not secured in an upright position (above). NOTE: Improper storage of oxygen and fuel gas cylinders in photo on left.

<u>RANK IN FREQUENCY CITED</u>	1926.	ADDITIONAL RULES FOR WELDING/CUTTING AS PER ANSI Z49.1 - 1967
#18	350(j)	

RULE: Additional rules. For additional detail not covered in this subpart, applicable technical portions of American National Standards Institute, Z49.1 – 1967, Safety In Welding and Cutting, shall apply.

INTENT:

This ANSI standard was incorporated by reference into the original OSHA construction standards and remains today. Its intent is to supplement the safety, requirement for gas welding. Additional requirements cover the following: 1) installation and operation of oxygen-fuel gas systems for welding and cutting; 2) fire prevention and protection; 3) protection of personnel; 4) health protection and ventilation; and 5) industrial applications. Construction industry applications are further subdivided by operation, those operations include: A) general; B) general maintenance welding and cutting operations; C) earth moving and grading equipment; D) fire protection and prevention; E) demolition; F) concrete construction and masonry; G) tunnels, shafts and caissons; H) marine piling and marine construction; I) batch plant and road paving; J) steel erection; K) transmission pipeline; and L) mechanical piping systems.

HARZARDS:

- Fire/explosion. Probable injuries range from death to minor burns.

(AMONG OTHER) SUGGESTED ABATEMENTS:

- A pre-job survey to identify all potential hazards and affected areas around the operation is critical.
- All fire prevention and protection rules absolutely must be followed.

SELECTED CASE HISTORIES:

- A welder was cutting braces on a catwalk of a conveyor when the catwalk collapsed falling approximately 30' to the ground killing the welder.
- Three employees were cutting (burning) a catwalk from the top of a 20,000 gallon ethanol storage tank which had been drained of liquid but the vapors were not purged. Vapors emanating from a gage hatch which was not sealed were ignited and the tank exploded. The three employees were fatally injured. The area (not designed for cutting purposes) was not properly inspected and authorized prior to the start of the operation.

COMMENTS:

1. The most common standard cited from ANSI 249.1-1967 is 3.2.4.3, which specifies a 20 foot minimum spacing or ½ hour minimum fire rated wall 5 feet high separating oxygen cylinders from fuel gas cylinders in storage. Other commonly cited standards include: using acetylene at a pressure greater than 15 psig (3.1.2) and failure to inspect and authorize an operation when welding or cutting must be done in a location not designed for such purposes (6.2.5).
2. This rule only applies to gas welding. It does not apply to arc welding, resistance welding or other non-gas welding procedures

ADDDITIONAL DOCUMENTS TO AID IN COMPLIANCE:

[1] Subpart J; [24]; [281]*

*- Referenced in 29 CFR 1926- Construction Standards

PHOTOGRAPHS, ILLUSTRATIONS and OTHER DOCUMENTS

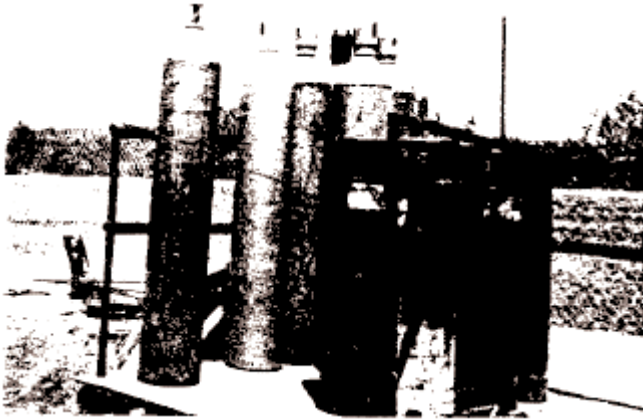

VIOLATION IN-COMPLIANCE

Oxygen and fuel gas cylinders stored together without proper separation or barriers.

NOTE: The missing valve protection cap on the front of the cylinder bottle.

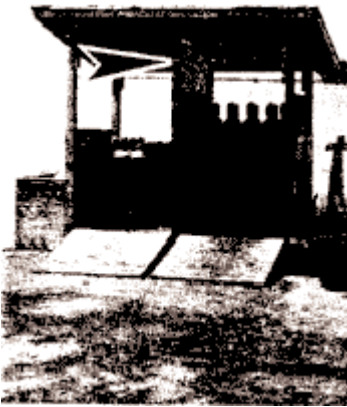

VIOLATION IN-COMPLIANCE

Oxygen cylinders in storage separated from fuel gas cylinders by a 5' tall properly constructed and rated fire wall (arrow).

<u>RANK IN FREQUENCY CITED</u>	1926.	
#19	102(a)(1)	EYE/FACE PROTECTION FOR OPERATIONS WHICH CREATE EXPOSURE

RULE: Employees shall be provided with eye and face protection equipment when machines or operations present potential eye or face injury from physical, chemical, or radiation agents.

INTENT:

There were about 22,000 lost-time accidents in the construction industry in 10 states from 1985-1989 due to eye injuries^[6]. Metal items (34.5%) and wood items (10.7%) were the most frequent sources of eye injuries. The purpose of the standard is obvious - to reduce the number of eye injuries. The rule requires employers to provide eye/face protection when there are potential hazards to the eye/face related to physical, chemical, or radiation agents. The key word is potential. On very few construction sites would potential for falling, flying, moving, etc. objects not be present. Sometimes pieces of debris break off, spring, eject, etc. from objects which are usually intact. Once airborne, potential exist to cause an eye/face injury (example - prying on a wooden box, when a splinter breaks due to the force (energy) of the prying operation, the splinter might be thrown in the direction of the employees face). Although these types of events are not normal, they can and should be expected because of the nature of construction work. Therefore, protection must be provided. Other standards in this Part include 1926.102(a)(2) which specifies that eye/face PPE will meet requirements of ANSI Z87.1-1968, UT^[15] and 1926.102(a)(5), which specifies that Table E-1^[1] shall be used as guidance for selecting appropriate protection for listed operations. This is a very useful and user friendly table. All spectacle type glasses listed in TABLE E-1 require sideshields. A footnote in the table states spectacles without sideshields are available when only frontal exposure is possible. Most construction operations would require sideshields.

HAZARDS:

- Struck by flying objects, particles, and chemicals. Probable eye injuries can range from blindness to minor irritation caused by foreign matter in the eye. Probable injuries to the face range from chemical burns caused by splashes to lacerations caused by flying objects.
- Radiant energy exposure from welding and laser operations. Probable injuries range from blindness to temporary eye irritation.

(AMONG OTHER) SUGGESTED ABATEMENTS:

- Instruct fast-line supervisors to continually audit employees to insure eye/face protection is worn.
- Institute a formal discipline program in workplaces where a problem exist relating to employees not wearing PPE when required.
- Make the wearing of PPE in accordance with company rules a specific condition of employment. This has proven to be an effective tool for safety managers (Conversations with safety managers).

SELECTED CASE HISTORIES:

IMIS data did not show violations of this standard contributing to the direct cause of a fatality/catastrophe. However, numerous severe lost-time injuries are related.

COMMENTS:

1. This rule requires employers to actually provide the eye/face protection to the employees.
2. This standard was cited in 17 fatality inspections conducted by OSHA in five years.

ADDITIONAL DOCUMENTS TO AID IN COMPLIANCE:

[1] Section 102, TABLES E-1, E-2 & E-3; [15]*; [25]

*- Referenced in 29 CFR 1926- Construction Standards

PHOTOGRAPHS, ILLUSTRATIONS and OTHER DOCUMENTS

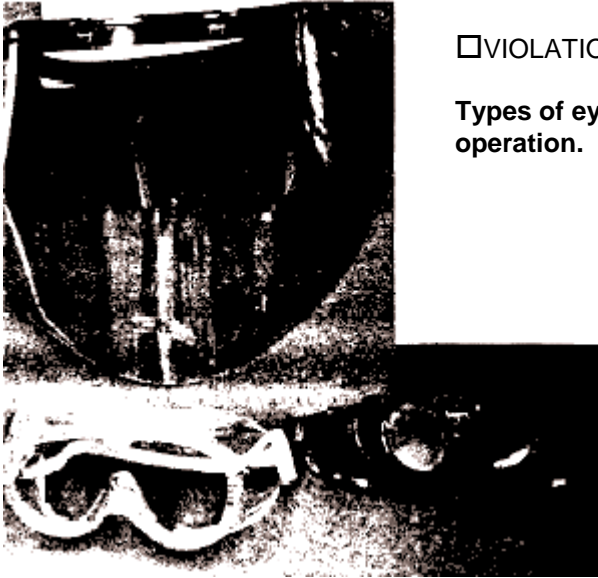

VIOLATION IN-COMPLIANCE

Types of eye and face protection that are required depending on the operation.

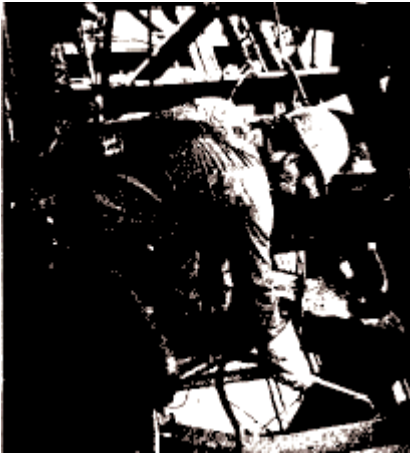

VIOLATION IN-COMPLIANCE

Employee is wearing the proper goggles while cutting steel for stairway.

<u>RANK IN FREQUENCY CITED</u>	1926.	
#20	500(b)(1)	GUARDING OF FLOOR OPENINGS

RULE: Floor openings shall be guarded by a standard railing and toeboards or cover, as specified in paragraph (f) of this section. In general, the railing shall be provided on all exposed sides, except at entrances to stairways.

INTENT:

OSHA defines a floor opening as "An opening measuring 12 inches or more in its least dimension in any floor, roof, or platform through which persons may fall." This rule is to specify that holes will be protected with guardrails and toeboards or covers. It also specifies the requirements of construction for the guardrails, toeboards and covers (1926.500(f)). An exemption is given guarding the exposed side of an entrance to a stairway. Table 5.2-1 and Table 5.2-2 give details for constructing standard guardrails and toeboards. Floor hole coverings must meet the construction specifications listed in 1926.500(f) (5). Regular floor hole covers must be capable of supporting the maximum intended load and must be installed to prevent accidental displacement and covers and their supports when located in roadways and vehicle aisleways for conduits, and manholes must be designed to carry a rear axle load of two times the maximum intended load.

HAZARDS:

- Fall from elevation. Probable injuries range from death to sprains/strains.
- Struck by falling objects through floor hole. Probable Injuries range from death to head concussion.

(AMONG OTHER) SUGGESTED ABATEMENTS:

- For new construction identify floor holes as they are created and take immediate action.
- For existing structures, survey the site prior to starting work and continue audit as renovation, repair, etc. proceeds for floor opening and holes.
- Insure all covers are constructed properly and will support the maximum intended load.

SELECTED CASE HISTORIES:

- An employee fell 16 feet to his death through an improperly guarded roof opening 36"x30" while attempting to stay clear of an overhead crane load. The improper guarding system consisted of four 2"x4" posts supported using only one nail per post and high visibility barrier tape strung between the posts.
- An employee fell through an uncovered 36" diameter hole in the top of a slurry tank and fell 32 feet to his death.

COMMENTS:

1. Many deaths occur each year when floor hole covers were removed and were not replaced or when they were constructed of materials that could not support the person/equipment load. (OSHA 1st Report of Death or Serious Injuries).
2. Toeboards are required to prevent materials from falling through the opening and striking persons below.
3. A floor hole is an opening measuring less than 12" but more than 1" in its least dimension. Floor hole protection is intended to prevent materials from falling to the level(s) below.
4. This standard was cited in 67 OSHA fatality cases in 5 years.

ADDITIONAL DOCUMENTS TO AID IN COMPLIANCE:

[1] sections 500(b) & (f); [19]

OSHA CLARIFICATION LETTER

Date 8/31/89; From Director of Construction Compliance Programs to Regional Administrator; Synopsis - A floor hole 60' x 40' x 12" deep in the middle of a large finished floor is not a floor opening or hole under this standard. Additionally, a uniform enforcement policy on floor openings is not possible because of the many variables that exist, i.e. the depth of the hole, workers exposure, etc.; therefore, each particular situation must be evaluated by the CSHO to determine if a hazard exists.

PHOTOGRAPHS, ILLUSTRATIONS and OTHER DOCUMENTS

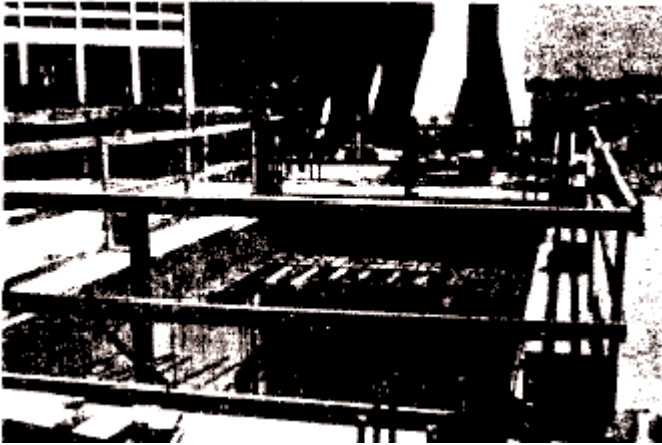

VIOLATION IN-COMPLIANCE

Properly erected standard guardrail system for floor opening.



VIOLATION IN-COMPLIANCE

Employee is wearing the proper goggles while cutting steel for stairway.

VIOLATION IN-COMPLIANCE

Unguarded floor opening (arrow) which exposes workers to a 9' fall into basement.



<u>RANK IN FREQUENCY CITED</u>	1926.	
#21	1053(b)(1)	LADDER EXTENDED 3' ABOVE LANDINGS

RULE: When portable ladders are used for access to an upper landing surface, the ladder side rails shall extend at least 3 feet (.9 m) above the landing surface to which the ladder is used to gain access; or, when such an extension is not possible because of the ladder's length, then the ladder shall be secured at its top to a rigid support that will not deflect, and a grasping device, such as a grabrail, shall be provided to assist employees in mounting and dismounting the ladder. In no case shall the extension be such that ladder deflection under a load would, by itself, cause the ladder to slip off its support.

INTENT:

The purpose of this rule is to provide protection for employees during two critical phases of ladder climbing: 1) when employees are on the ladder and their movement may cause forces to be transferred to the ladder and it's support points which might tend to make it slip or fall; and 2) when the employee is either getting on or off the ladder - if nothing is available to grab and provide support the employee will be in a bent over position and his/her center of gravity may be outside the vertical line of normal body position in an attempt to correct this and straighten up and get onto the ladder the employee is vulnerable to a fall. The rule specifies: 1) that the side rails must extend three feet above the landing; 2) side rails must be secured at the top to a rigid support when the 3 foot extension is not provided (this can be done by tying with rope boxing in with lumber, etc.); 3) a grab device must be provided when the ladder's side rails do not extend 3 feet above the landing (the grasping device can be constructed of materials such as metal, lumber, etc., it can be a part of the structure providing it's location does not create a hazard in itself and it's easy grasped); and 4) when employees are on the ladder its deflection cannot cause it to slip off its support; therefore, when selecting/spotting a ladder, consider the amount it will deflect during use to assure that the proper length is used.

HAZARDS:

Fall from elevation. Probable injuries range from death to sprain/strains.

(AMONG OTHER) SUGGESTED ABATEMENTS:

- Abatement is obvious - construct/use ladders according to specification requirement.
- Instruct first-line supervisors to inspect ladders during each shift in their work area.

SELECTED CASE HISTORIES:

An employee was climbing a 10 foot ladder to access a landing which was 9 feet above the adjacent floor. The ladder slid down and the employee fell to the floor, sustaining fatal injuries. Although the ladder had slip-resistant feet, it was not secured, and the railings did not extend 3 feet above the landing.

COMMENTS:

1. This standard covers only portable ladders. A similar requirement for fixed ladders is 1926.1053(a)(24).
2. This is a specification standard which is easily identified and substantiated as a violation as evident by it's high ranking on the 100 **Most Cited Physical List**. Therefore, the contractor must continually audit the site to remain in compliance with this item.
3. The standard was cited in 6 fatality/catastrophe inspections since January, 1991.

ADDITIONAL DOCUMENTS TO AID IN COMPLIANCE:

[1] Subpart X; [18]

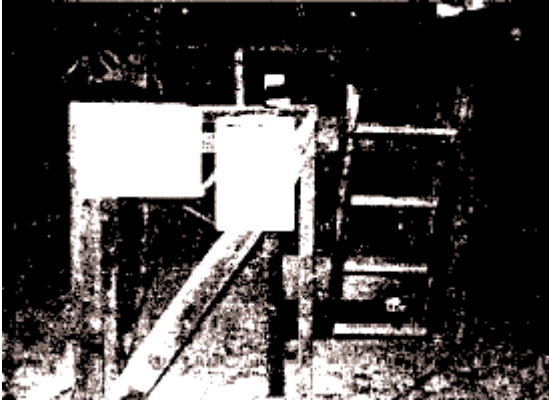

VIOLATION IN-COMPLIANCE

The portable ladder extends 3' above the opening (landing) of the confined space.

NOTE: The guarding of the floor hole except at the entrance for the ladder is acceptable.

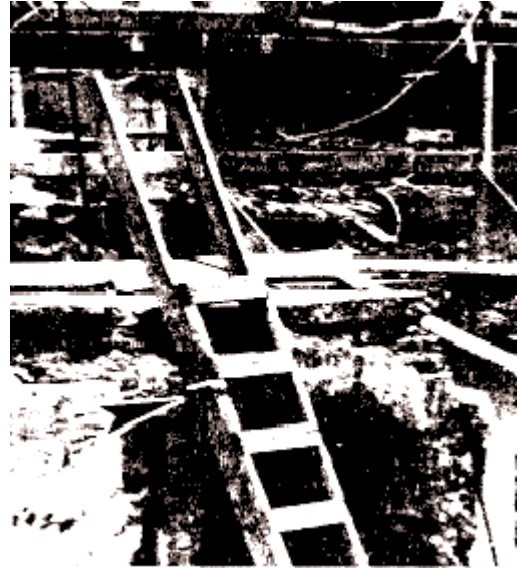

VIOLATION IN-COMPLIANCE

The job made ladder is secured (arrow) and extended 3' above the landing.

NOTE: The exposure to the open-sided floor when employees are on the landing would be a violation of 1926.500(d)(1)

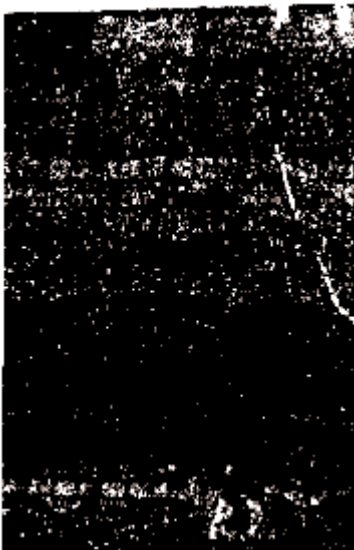

VIOLATION IN-COMPLIANCE

The job made ladder does not extend at least 3' above landing, nor is it secured against tipping.

<u>RANK IN FREQUENCY CITED</u>	1926.	
#22	651(c)(2)	EGRESS FROM TRENCH/EXCAVATION

RULE: Means of egress from trench excavations. A stairway, ladder, ramp or other safe means of egress shall be located in trench excavations that are 4 feet (1.22 m) or more in depth so as to require no more than 25 feet (7.62 m) of lateral travel for employee.

INTENT:

When conditions begin to deteriorate in a trench, such as soil beginning to slug off the face of the trench, the risk of a cave-in increases and emergency egress may be required. This standard requires a means of egress. The intent of the rule is to specify the following: 1) maximum lateral distances an employee can travel (25 feet) to egress a trench; 2) maximum depth of the trench (4 feet) when egress must be provided; and 3) means in which egress from the trench can be accomplished, i.e. stairway, ladder, ramp, or other safe means. Note: It is not intended that this rule apply to large excavations ([14], pg. 45918). However, a safe means of access/egress from large excavations must be provided as per 29 CFR 1926.1051(a). That standard requires a stairway or ladder be provided at personnel points of access where there is a break in elevation of 19 inches or more, and no ramp runway, sloped embankment or personnel hoist is provided.

HAZARDS:

- Cave-in. Probable injury is death.
- Hazardous atmospheres caused by broken utility lines, toxic materials entrained in soil, etc. Large range of injuries from death due to inhalation of toxic material to first aid.

(AMONG OTHER) SUGGESTED ABATEMENTS:

- Provide properly constructed /maintained means of egress at predetermined points.

SELECTED CASE HISTORIES:

- Two employees were in a 12 foot deep trench laying pipe when one of the employees saw the bottom face of the trench move and jumped out of the way along the length of the trench as the wall caved-in fatally injuring the other employee. The walls of the trench were vertical and no means of emergency egress was provided.
- Two employees laying sewer pipe were in a 15 foot deep trench, which was not shored or sloped properly. The employees had to egress the trench by climbing the backfill. While exiting the trench the first worker was trapped by a small cave-in. The second employee tried to extricate him but a second cave-in occurred trapping the second employee at the waist. The second cave-in actually caused the death of the first employee; the second employee sustained a hip injury.

COMMENTS:

1. Only one means of egress is required in the middle of a trench 50' long to meet the requirements of this standard.
2. Earthen ramps may be used as a suitable means of egress only if employees can walk the ramp in an upright position when entering and exiting. The earthen ramp must be evaluated as acceptable by the competent person.
3. This standard was cited in 24 fatality inspections conducted by OSHA since January 1991.

ADDITIONAL DOCUMENTS TO AID IN COMPLIANCE:

[1] Subpart P; [14]; [20]

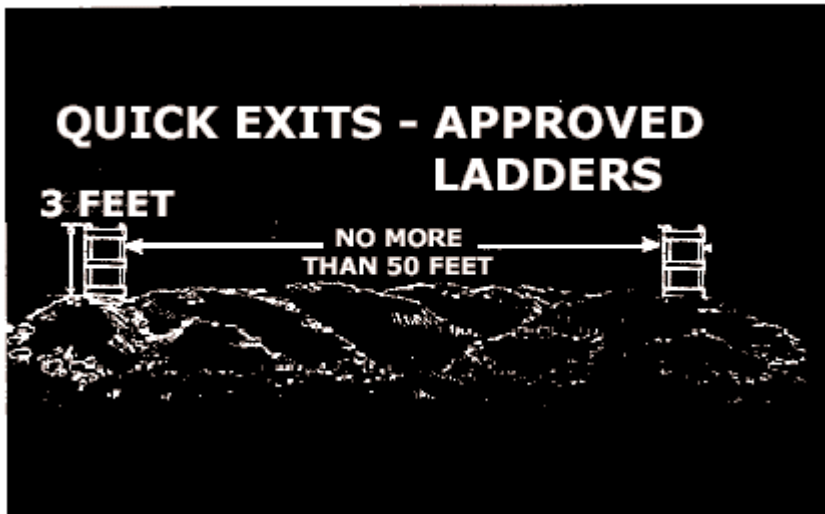

VIOLATION IN-COMPLIANCE

Required for trench/excavations \geq 4 feet deep.



VIOLATION IN-COMPLIANCE

No means of egress provided. Employee is riding backhoe bucket out of trench.

<u>RANK IN FREQUENCY CITED</u>	1926.	LISTED, LABELED OR CERTIFIED EQUIPMENT USED IN MANNER PRESCRIBED
#23	403(b)(2)	

RULE: Listed, labeled, or certified equipment shall be installed and used in accordance with instructions included in the listing, labeling, or certification.

INTENT:

At times electrical equipment is installed or used in a manner for which it was not designed. This is one of the electrical standards which is used as a "catch all" for hazardous situations which are not covered by specific electrical standards. While the application of this standard may be broad, the intent is to ensure that all electrical equipment is used/installed as designed. The most common specific application of this standard as used by OSHA in construction is to address the situation when a multiple-receptacle box designed to be mounted is fitted with a power cord and placed on the floor to provide power for various tools. This would not be a prescribed use for the receptacle box. OSHA also cites this standard for the use of ROMEX[®] wire for making up extension cords; using equipment outdoors which is only listed and labeled for indoor dry locations (this can even apply to double insulated tools which are listed and labeled for dry indoor locations only); short two-prong adapter plugs with pig tail equipment grounding connections to facilitate the attachment of cords and tools to electrical systems; and the use of the wrong size circuit breakers or fuses for overcurrent protection. The situations listed above would not be in accordance with the equipment's prescribed use.

HAZARDS:

- Electrical shock. Probable injuries can vary from death to minor burns.
- Fire. Probable injuries can vary from third degree to minor burns.

(AMONG OTHER) SUGGESTED ABATEMENTS:

- Since most violations rated to this standard are the result of original equipment being shop fabricated, altered, modified, etc. instruct first-line supervisors to watch for such equipment and determine if it is in compliance with OSHA/NEC. If not, take equipment out of service immediately.

SELECTED CASE HISTORIES:

An employee was texturing a wall using an air compressor. The plug of the compressor and an extension cord had been modified to fit a wall outlet for a common household dryer (220 V). While attempting to unplug the compressor from the extension cord, the employee was fatally shocked. The modification to the plugs was not an intended use or prescribed by the manufacturer.

COMMENTS:

1. The shop-fabricated multi-receptacle box laying on the floor is quite common in the industry. After, OSHA CSO's become familiar with this problem it becomes as easy a violation to identify and substantiate as many of the specification standards.
2. If an installation is made in accord with the 1984 National Electric Code, it will be considered to be in compliance with Section 1926.403 thru 1926.408, except 1926.404(b)(1), 1926.405(a)(2)(ii)(E), 1926.405(a)(2)(ii)(F), 1926.405(a)(2)(ii)(G), & 1926.405(a)(2)(ii)(J).
3. This standard was cited in seven fatality inspections conducted by OSHA in 5 years.

ADDITIONAL DOCUMENTS TO AID IN COMPLIANCE:

[1] Subpart K; [2]; [3]

PHOTOGRAPHS, ILLUSTRATIONS and OTHER DOCUMENTS



VIOLATION IN-COMPLIANCE

Multi-receptacle outlet box on the floor providing power to 3 extension cords. The supply power to the outlet box is provided by non-metallic sheath (NM) cable (arrow). The manner in which the outlet box and NM cable is used is not a prescribed use.



VIOLATION
 IN-COMPLIANCE

NM cable is being run across a field (above) to provide power to an outlet laying on ground (blow-up). It is being utilized as an extension cord. The use of the NM cable and outlet in this manner is not a prescribed use. NOTE: The NM cable is run on ground is not protected from damage (this particular cable was run across a subdivision street). When NM cable is used on a construction site it must be used in a manner prescribed such as wiring for feeders, branch lines and temporary lighting. Additionally, it must be installed properly and must be protected from physical damage.

<u>RANK IN FREQUENCY CITED</u> #24	1926. 405(a)(2)(ii)(j)	FLEXIBLE CORDS DESIGNATED FOR HARD OR EXTRA HARD USAGE
---	---	---

RULE: Extension cord sets used with portable electric tools and appliances shall be three-wire type and shall be designed for hard or extra-hard usage. Flexible cords used with temporary and portable lights shall be designed for hard or extra hard usage.

INTENT:

Extension cords when exposed to even “normal” construction use can experience rapid deterioration. When this happens, conductors with energized bare wires can be exposed. Conductors can break or come loose from their terminal screws, specifically the equipment grounding conductor. If that should occur the equipment grounding for the tool in use is lost. Since deterioration occurs more rapidly in cords which are not rugged enough for construction conditions, the National Electric Code ^[5] and OSHA have specified the types of cords to use in a construction environment. This rule designates the types of cords that must be used for various applications including portable tools, appliances, temporary and portable lights. The cords are designated **HARD and EXTRA HARD SERVICE** Examples of **HARD SERVICE** designation types include **S, ST, SO, STO, SJ, SJO, SJT & SJTO** Extension cords must be durably marked as per 1926.405(g)(2)(ii) with one of the HARD or EXTRA HARD SERVICE designation letters, size and number of conductors.

HAZARDS:

Electrical shock. Probable injuries range from death to minor burns.

(AMONG OTHER) SUGGESTED ABATEMENTS:

Continually audit cords on-site. Any cords found not to be HARD or EXTRA HARD SERVICE must be taken out of service immediately.

SELECTED CASE HISTORIES:

An employee received a fatal shock when he was cutting drywall with a metal casing router. The router’s 3-wire power cord had been spliced to a 2-wire cord and plug. A fault occurred and with no grounding and the absence of GFCI protection, the employee was electrocuted. The cord was not a 3-wire HARD SERVICE variety.

COMMENTS:

1. The durable marking required to be on the cord can be found as an indelible marking by the manufacturer approximately every foot along the length of the cord.
2. Because the use of extension cords is so numerous at construction sites and this is a specification standard, the number of related violations is quite high. For the OSHA CSHO this situation is relatively easy to identify and substantiate as a violation.
3. Because of the constant movement of contractors and equipment, specifically extension cords, on/off-site and the fact that sometimes several contractors draw power utilizing the same extension cord, identifying improper service cords may be difficult.
4. This standard was cited in 20 fatality inspections in last 5 years.

ADDITIONAL DOCUMENTS TO AID IN COMPLIANCE:

[1] Sections 405(b) & (g); [2], [3]

OSHA CLARIFICATION LETTER

Date 3/3/92; From Director of Compliance Programs to Director of Office of Construction and Engineering; Synopsis – Contractor shop-made extension cords are acceptable if they meet the following criteria; 1) all individual components of the cord set must be approved by a nationally recognized testing laboratory; 2) the cord sets must meet all applicable requirements such as strain relief, correct polarity of conductors, proper marking, etc.; 3) cords must be assembled by a qualified person; and 4) the cord set must be checked prior to its first use, for example, the following tests should be performed a) all equipment grounding conductors shall be tested for continuity and shall be electrically continuous and b) each receptacle and attachment plug must be tested to insure proper connection of the equipment grounding conductor to its appropriate terminal.

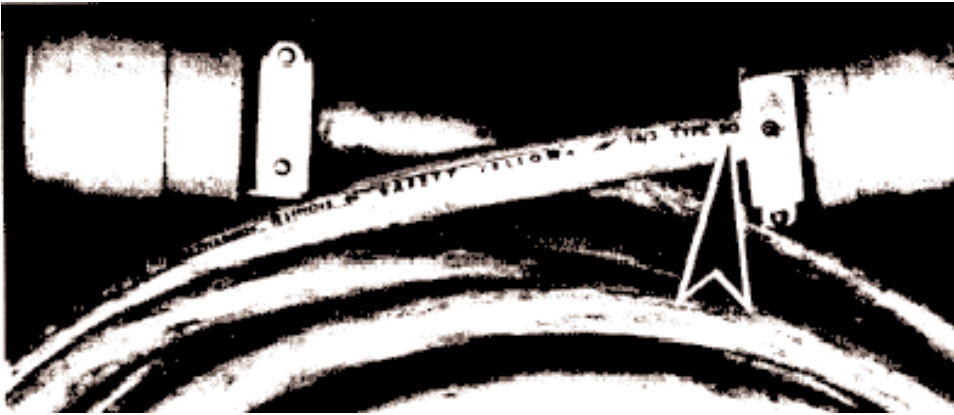

VIOLATION **IN-COMPLIANCE**

Hard service cord TYPE SO (arrow).
NOTE: The strain relief devices for
ends of the attachment plugs.

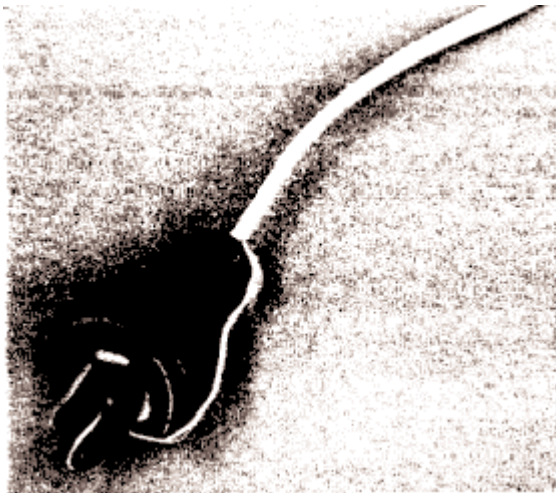

VIOLATION IN-COMPLIANCE

2 wire ribbon type cord is not designed for **HARD USAGE**.

NOTE: The 2 wire cord does not provide equipment grounding. Additionally, there are exposed terminal screws and conductors on the end of the cord which create a shock hazard.

<u>RANK IN FREQUENCY CITED</u>	1926.	
#25	405(g)(2)(iv)	STRAIN RELIEF FOR CORDS

RULE: Flexible cords shall be connected to devices and fittings so that strain relief is provided which will prevent pull from being directly transmitted to joints or terminal screws.

INTENT:

The deterioration of electrical cords on construction sites is a common occurrence. If a cord deteriorates to a point where conductors have effectively worn through their insulation or equipment grounding conductors are no longer attached to their terminal screws, an electric shock hazard is created. Many times deterioration of the cord is due to the strain, both normal and abnormal, it experiences on the site. One of the weak points of a cord assembly is the area in which attachments are made (plug cap and connector body). When devices or fittings designed to relieve cord strain are not used, insulation will tend to pull back and expose conductors or the conductors will loosen from their terminal screws. Therefore, this standard requires hardware to prevent tension from being transmitted to joints and terminal screws. Manufactured molded plug caps and associated connections usually do not pose this problem under normal use. However, site-fabricated cords or cords that have been repaired in the field frequently do not have sufficient strain relief. Loose wires in a plug cap caused by improper connection or tension due to no strain relief can cause conductors to make contact where not intended causing short-circuit, fires, arcing type explosion, etc.

HAZARDS:

Electrocution and fire. Probable injuries can range from death to first degree burns.

(AMONG OTHER) SUGGESTED ABATEMENTS:

- Use approved cords for HARD or EXTRA HARD USAGE (Designated S, ST, SO, STO, SJ, SJO, SJT or SJTO).
- Use only cords which are equipped or designed with strain relief.
- Use factory-assembled cord sets as much as possible.
- Reinforce the simple work practice that everyone learned when they were children -remove cords from receptacles by pulling on the plugs, not the cords.

SELECTED CASE HISTORIES:

An employee operating a 3/4" electric chisel was electrocuted. An electrical fault occurred in the casing of the tool. An inspection revealed that the original power cord had been replaced with a flat cord (not designed for HARD service), the ground prong was missing and strain relief was not provided for the cord at the point it entered the tool. Additionally, no GFCI protection was provided.

COMMENTS:

1. There is no prohibition against fixing a cord or reattaching it to a plug. However, care must be taken to assure the original electrical and mechanical integrity of the cord is maintained.
2. Splices to flexible cords and cables are prohibited under 1926.405(g)(2)(iii) if their service rating is less than Hard Service No. 12. If the service rating is greater than No. 12 splices may be made provided they meet other mechanical requirements.
3. This standard was cited in 20 fatality inspections conducted in five years.

ADDITIONAL DOCUMENTS TO AID IN COMPLIANCE:

[1] Section 405; [2]; [3]; [21] Fact Sheet #5; Pull at Joints & Terminals Must Be Prevented

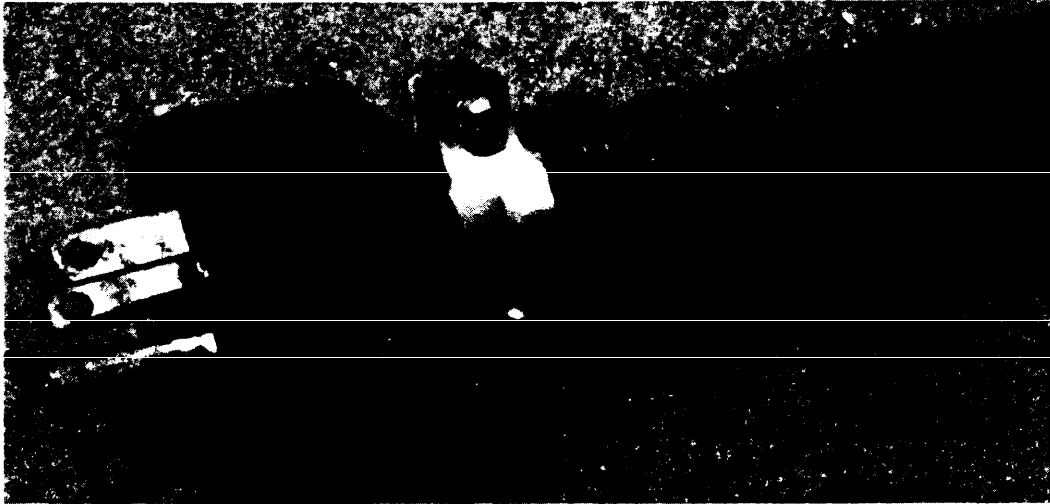

VIOLATION IN-COMPLIANCE

Strain relief provided for plug on cord.

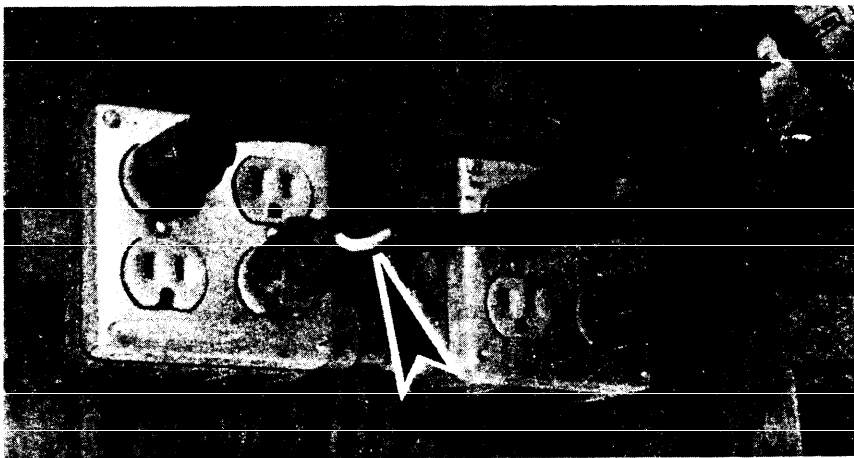

VIOLATION
 IN-COMPLIANCE

The insulation of the cord (arrow) is pulling away from plug. The plug had earlier been repaired and its original molded plug strain relief was compromised. Additionally, strain relief was not provided at the time of repair resulting in condition shown above.

5.2 CONSTRUCTION SPECIFICATIONS FOR GUARDRAILS AND TOEBOARDS

The following section presents construction specifications for guardrails and toeboards. These specifications relate to **GUIDE** Sheets #1, #6, # 12, # 15 and #20 listed above in Section 5.1. These tables compile the requirements for "standard guardrails and toeboards or their equivalent". Table 5.2-1 lists construction specifications for guardrails and Table 5.2-2 lists construction specifications for toeboards.

TABLE 5.2-1

MINIMUM SPECIFICATIONS FOR GUARDRAIL SYSTEMS

TYPE OF MATERIAL	SIZE OF TOP/MID RAIL [IN]	HEIGHT [IN] TOP RAIL ⁽¹⁾	POST SIZE/SPACING ⁽²⁾	STRENGTH ⁽³⁾ [LBS.]
WOOD	2x4/1x6	42	2"x4"/8'	200
PIPE	1-½ nominal OD	42	1-½ nom./8'	200
STEEL	2x2x3/8 angle	42	2"x2"x3/8" angle/8'	200 or equiv. bend. strength
WIRE ROPE	3/8 ⁽⁴⁾	42	equivalent to one of above	200
OTHER EQUIVALENT	equivalent to one of above	42	equivalent to one of above	200

(1) Acceptable heights range from 39" to 45" (42" ± 3"). Mid rail height should be about ½ height of top rail.

(2) Spacing is horizontal distance measured center post to center post

(3) Railing must have minimum deflection in any direction 200 lb. force is applied. Minimum deflection is not defined although 3" of deflection for wire rope after force is applied is a guideline. Strength criteria also applies to all structural members of system including post anchorages

(4) There is no present OSHA National Office guidance at this time for size of wire rope guard rails. 3/8" is a recommended size, however, any wire rope size ¼" or larger (as per NPRM for Subpart M) would be acceptable. OSHA requires a ½" wire rope or equivalent for periphery of floors during steel erection.

Note - Lumber sizes listed above can be nominal size.

TABLE 5.2-2

MINIMUM SPECIFICATIONS FOR TOEBOARDS

HEIGHT OF PROTECTION ⁽¹⁾	MATERIAL	CONSTRUCTION	SIZE
Standard Toeboard <u>Does Provide</u> Protection	Substantial	1) Solid 2) Opening < 1" 3) ¼ " max. clear. from floor	4" min. (vertical dimension)
Standard Toeboard <u>Does Not Provide</u> Protection	Substantial	Paneling or Screening	Floor to Mid or Top Rail

(1) The size of the material containment, i.e. toeboard is dictated by the size of the material or the way it is piled. A standard toeboard may not be sufficient to contain items near the edge of an open-sided floor/platform. In that case the height of the containment must be increased accordingly.

5.3 REFERENCES

1. 29 CFR 1926/1910: Construction Industry - OSHA Safety and Health Standards: OSHA 2207; Revised 1991; U.S. Department of Labor, Occupational Safety and Health Administration, Washington, DC.
2. Electrical Standards for Construction: OSHA 3097; 1989 (Revised); U.S. Department of Labor, Occupational Safety and Health Administration, Washington, DC.
3. An Illustrated Guide to Electrical Safety: OSHA 3073; 1983 (Revised); U.S. Department of Labor, Occupational Safety and Health Administration, Washington, DC.
4. Ground Fault Protection on Construction Sites: OSHA 3007; 1990 (Reprint); U.S. Department of Labor, Occupational Safety and Health Administration, Washington, DC.
5. ANSI/NFPA 70-1990: National Electrical Code; 1990; National Fire Protection Association, Batterymarch Park, Quincy, MA.
6. Construction Accidents: The Workers' Compensation Data Base 1985-1988; April 1992, U.S. Department of Labor, Occupational Safety and Health Administration, Office of Construction and Engineering, Washington, DC.
7. ANSI 289.1-1969; Safety Requirements for Industrial Head Protection 1969; American National Standards Institute, New York, NY.
8. ANSI Z89.2-1 971; Safety Requirements for industrial Protective Helmets for Electrical Workers; 1971; American National Standards Institute, New York, NY.
9. Personnel Protective Equipment: OSHA 3077; U.S. Department of Labor. Occupational Safety and Health Administration, Washington, DC.
10. Analysis of Construction Fatalities -The OSHA Data Base 1985-1988; Nov. 1990; U.S. Department of Labor, Occupational Safety and Health Administration, Office of Construction and Engineering, Washington, DC.
11. Safety Standards for Fall Protection in the Construction Industry; Notice of Proposed Rulemaking; Part III; Federal Register; Nov. 25, 1986; U.S. Department of Labor, Occupational Safety and Health Administration, Washington, DC.
12. ANSI 910.14-1 975. Requirements for Safety Belts, Harnesses, Lanyards, Lifelines, and Droplines for Construction and Industrial Use; 1971; American National Standards Institute, New York, NY.
13. ANSI-A10.11-1979; Standard for Safety Nets Used During Construction, Repair and Demolition 1979; American National Standards Institute, New York, NY.
14. 29 CFR Part 1926 Occupational Safety and Health Standards-Excavations: Final Rule: Part II; October 31, 1989; U.S. Department of Labor, Occupational Safety and Health Administration, Washington, DC.
15. ANSI 287.1-1968. Practice for Occupational and Educational Eye and Face Protection, 1968, American National Standard's Institute, New York, NY.
16. 29 CFR 1910.134; Respiratory Protection, U.S. Department of Labor, Occupational Safety and Health Administration, Washington, DC.

17. ANSI A10.8-1988; Scaffold Safety, 1988, American National Standards Institute, New York, NY.
18. 29 CFR 1926 Safety Standards for Stairways and Ladders Used in Construction Industry; Final Rule; Part III, Nov. 14, 1990, U.S. Department of Labor, Occupational Safety and Health Administration, Washington, DC.
19. ANSI A10.18-1983 Construction and Demolition Operations: Temporary Floor and Wall Openings, Flat Roofs, Stairs, Railings, and Toeboards – Safety Requirements, 1983, American National Standards Institute, New York, NY.
20. Excavations; OSHA 2226; (Revised 1991), U.S. Department of Labor, Occupational Safety and Health Administration, Washington, DC.
21. OSHA Electrical Hazard Fact Sheets, Revised Nov. 1983; William Watkins, PE for U.S. Department of Labor, Occupational Safety and Health Administration, OSHA Training Institute, Des Plaines, IL
22. Selected Occupational Fatalities Related to Welding and Cutting as Found in Reports of OSHA Fatality/Catastrophe Investigations; August 1988, W. Cole, U.S. Department of Labor, Occupational Safety and Health Administration, Directorate of Policy, Washington DC.
23. ANSI Z49.1-1967 Safety in Welding and Cutting, American National Standards Institute, New York, NY.
24. NGPA 51 – 1992 Standard for the Design and Installation of Oxygen – Fuel Gas Systems for Welding, Cutting and Allied Operations, 1992, National Fire Protection Association, Quincy, MA
25. Personnel Protective Equipment; OSHA 3077; U.S. Department of Labor, Occupational Safety and Health Administration, Washington, DC.
26. Concrete and Masonry Construction; Final Rule, June 16, 1988; U.S. Department of Labor, Occupational Safety and Health Administration, Washington, DC.
27. ANSI A10.9 – 1983 Concrete and Masonry Work – Safety Requirements; (Supplement A10.9A – April 1989); 1983; American National Standards Institute, New York, NY.
28. ANSI Z49.1 – 1967 Safety and Welding and Cutting; American National Standards Institute, New York, NY.
29. Employers Safety and Health Program; Appendix A; OSHA Instruction STD 3-1.1; June 22, 1987; Office of Construction and Maritime Compliance Assistance; U.S. Department of Labor, Occupational Safety and Health Administration, Washington, DC.
30. Excavation Safety: Excavation, Trenching and Soil Mechanics; Appendix A; J.L. Mickle, PhD., PE (G. Bradberry author of Appendix A), for the U.S. Department of Labor, Occupational Safety and Health Administration, OSHA Training Institute, Des Plaines, IL
31. National Electrical Code Diagrams; William Watkins, PE for U.S. Department of Labor, Occupational Safety and Health Administration, OSHA Training Institute, Des Plaines, IL

INDEX

5(a)(1) 9, 13, 19, 29, 45

-A-

access v, 8-10, 18-20, 23, 24, 46, 54, 72, 74
 AEGCP 36, 37, 56
 ANSI 8, 9, 18, 19, 21, 25, 26, 29, 34, 35, 66, 68, 84, 85
 approved containers . . . vii, 2, 18, 20, 26, 37, 48, 49, 56,
 78, 80
 assured equipment grounding conductor
 program 20, 23, 36

-B-

backup alarm 10, 20, 26
 body belt 20
 branch circuit 10, 20, 56

-C-

combustible 18, 21, 25, 48
 competent person 20, 21, 25, 36, 40, 52, 53, 74
 cord 17, 23, 36-39, 56, 76-81
 crane 21, 25, 70

-D-

daily inspection 18, 52, 53, 62

-E-

egress 8, 10, 18, 20, 24, 46, 74, 75
 emergency 4, 9, 19, 26, 74
 excavating 18, 21, 40, 52
 excavation . . . 11, 18, 22, 25, 40, 41, 52, 53, 62, 74, 85
 extension cord 37-39, 56, 76-78

-F-

fall prevention 28, 32, 42, 60
 fall protection 10, 18-20, 22, 25, 32, 42, 44, 45, 60, 61, 84
 fire extinguisher 3, 10, 20, 21, 25
 first-aid 4, 10, 19, 20, 26
 fixed ladder 32, 54
 flammable 18, 21, 25, 48
 floor hole 70, 73
 floor opening 8, 70, 71
 fork lifts 21

-G-

gas cylinder 64
 general duty clause 9, 29, 45
 GFCI 18, 22, 23, 36, 37, 56, 57, 78, 80
 ground fault circuit interrupter 8
 ground fault protection 7, 17, 18, 23, 36, 56, 84
 grounding . . . 7, 9, 10, 19, 20, 23, 36-39, 56, 76, 78-80
 guardrail iv, 7, 18, 24, 32, 33, 42, 43, 46, 54, 60, 71, 82

-H-

hardhat 35
 HAZ. COMM. 7, 9-11
 head protection 7, 18, 25, 34, 35, 44, 84
 housekeeping 7, 18, 26, 50, 51

-I-

inspection 1, 3, 4, 11, 17, 18, 20, 21, 25, 52, 53, 62, 80

-L-

ladder . . 8-11, 18-20, 22, 24, 32, 34, 35, 38, 46, 54, 55,
 60, 61, 72, 73, 74
 lanyard 3, 10, 20, 32, 42, 44, 60

-M-

medical access 8
 mobile scaffold 9, 20, 24
 MSDS 7

-N-

no smoking 21, 48

-O-

open sided floors vii, 1, 7, 18, 25

-P-

platforms 18, 25, 32, 42, 43, 54, 60, 61
 portable ladder . . . 9, 10, 19, 20, 24, 37, 48, 54, 56, 57,
 61, 72, 73, 78
 PPE 4, 7, 18, 22, 25, 44, 45, 68
 program . . . iv, 2, 4, 7, 9, 10, 19, 20, 23, 28, 34, 36, 52,
 68, 85

-R-

rebar 58, 59
 runway 10, 74

-S-

scaffold . . . 8-11, 20, 24, 28, 34, 35, 42, 43, 54, 55, 60,
 61, 85
 spoil pile 8, 18, 53, 62, 63
 stair rail 7, 20, 24
 stairway 9-11, 18-22, 24, 32, 46, 47, 54, 69, 70, 74
 strain relief 8, 18, 23, 39, 78-81

-T-

temporary lights 20, 23
 temporary wiring 20, 23, 37, 56
 toeboard 32, 42, 43, 60, 83
 training v, vii, 1, 2, 4, 7, 9, 27, 52, 85
 trench 7, 8, 18, 22, 40, 41, 52, 53, 62, 63, 74, 75
 tubular welded frame scaffold 20, 24, 42

-U-

UL 48

-V-

vehicles 21, 26

-W-

wall opening 9
 welding 8, 18, 20-22, 26, 29, 64, 66, 68, 85